

PRODIGY.MP

User's Manual



Copyright

All rights reserved. Permission to reprint or electronically reproduce any document or graphic in whole or in part for any reason is expressly prohibited, unless prior written consent is obtained from the DirectOut GmbH.

All trademarks and registered trademarks belong to their respective owners. It cannot be guaranteed that all product names, products, trademarks, requisitions, regulations, guidelines, specifications and norms are free from trade mark rights of third parties.

All entries in this document have been thoroughly checked; however no guarantee for correctness can be given.

DirectOut GmbH cannot be held responsible for any misleading or incorrect information provided throughout this manual.

DirectOut GmbH reserves the right to change specifications at any time without notice.

DirectOut Technologies® is a registered trademark of the DirectOut GmbH.

© DirectOut GmbH, 2025

Table of contents

About This Manual	7
How to Use This Manual.....	7
Conventions	7
CHAPTER 1: Overview	8
Introduction	8
Feature Summary.....	9
How it works	10
Applications.....	10
CHAPTER 2: Legal issues & facts	12
Before Installing This Device.....	12
Defective Parts/Modules	12
First Aid (in case of electric shock).....	13
Updates	14
Conditions of Warranty	14
Intended Operation	14
Conformity & Certificates	15
Contact.....	15
Contents.....	16
Accessories.....	17
CHAPTER 3: Installation	22
Installing the Device.....	22
CHAPTER 4: Operation	26
Introduction	26
Global Control.....	27
Managing Device	28
Networking.....	29
Slots - Connecting Audio.....	31
Slot A - Audio Network, Multi-Port MADI, USB.....	32
Slot B - Single-Port MADI	44
Slot C - Converter AD/DA, Mic, AES3.....	48
Word clock	60
Clocking.....	61
USB	62
MIDI	63
GPIO.....	63

CHAPTER 5: Managing Device	64
Introduction	64
Getting started	65
Local operation	66
MAIN MENU	67
HOME	68
CLOCK	70
SNAPSHOTS	76
NETWORK	78
SETTINGS	80
INFO	84
INFO	85
LEVEL METER - INPUT (MIC8.LINE.IO)	87
LEVEL METER - INPUT (AN8.IO)	88
LEVEL METER - OUTPUT	89
CHAPTER 6: Troubleshooting and Maintenance	90
Troubleshooting	90
Maintenance	91
CHAPTER 7: Technical Data	92
Index	98
Appendix A - DSUB-25 Pin assignment	100
Appendix B - DSUB-9 Pin assignment	101
Appendix C - Dimensions	102
Appendix D - System Update & License Installation	103

This page is left blank intentionally.

This page is left blank intentionally.

About This Manual

How to Use This Manual

This manual guides you through the installation and operation of the device. Use the Table of Contents at the beginning of the manual or Index Directory at the end of the document to locate help on a particular topic. You can access more information and latest news by visiting on the DirectOut website at www.directout.eu.

Conventions

The following symbols are used to draw your attention to:

TIPS

indicate useful hints and shortcuts.



NOTES

are used for important points of clarification or cross references.



WARNINGS!

alert you when an action should always be observed.



CHAPTER 1: Overview

Introduction

Welcome to PRODIGY.MP, DirectOut's multifunction audio processor supporting multiple formats, flexible I/O, dual network audio, DSP functions, sample rate conversion and powerful hard- and software.

PRODIGY.MP has been designed to address numerous applications in live sound, broadcast, installation and recording, and it's hardware can be configured to specific requirements.



Feature Summary

Slot A Audio Network / Multi-port MADI Modules USB*	2 slots - Dante (64 ch) - RAVENNA (128 ch) - SoundGrid (128 ch) - AVB / MILAN (128 ch) - MADI2 (128 ch) - BNC or SFP - USB (128 ch)
Slot B Single-port MADI Modules*	2 slots - SFP (empty cage without module) - SC-Socket multi/single-mode - coaxial BNC, 75 Ω
Slot C Converter Modules*	4 slots - individually configurable - 8 channels each: - Analog I/O - Line In / Out - Mic I/O - Mic In / Line Out - Digital I/O - AES3 In / Out
Headphones	1 x 6.3 mm jack & 1 x 3.5 mm jack
Word Clock (I/O):	4 x coaxial BNC (WCK2 switchable to Video sync) (75 Ω termination switchable)
Supported Audio Network Standards (depending on module)	Dante / AES67 RAVENNA / AES67, ST 2110-30 /-31, ST 2022-7 SoundGrid AVB / MILAN
Sample Rate Conversion	FastSRC™ on Slot A and Slot B modules HD SRC on Slot A modules with SRC option AES4.SRC.IO modules for AES3 inputs
DSP Functions	Flex Channels with EQ, Dynamics, Delay Matrix Mixers, Summing Busses, External Insert- Points, DSP Routing
MADI Formats	56/57/64 channel, High Speed or Legacy Native or 48k/96k Frame, S/MUX
Sample Rates	44.1, 48, 88.2, 96, 176.4, 192 kHz +/-12.5%
Management Port	1 x SFP, 2 x RJ45 Socket (Gigabit-Ethernet)
Device Control	remote: via globcon or browser, Ember+, OSC, HOME local: via touch-display
MIDI	2 x DIN socket
GPIO	1 x DSUB-9 (2 x GPI, 2 x GPO, MOSFET switches)
USB Port	2 x USB 2.0 port for legacy control of ANDIAMO devices

Power Supply	This device is equipped with two wide range power supplies (84 V to 264 V AC / 47 Hz to 63 Hz / safety class 1)
--------------	---

* see „Slots- Connecting Audio“ on page 31 for a comprehensive description of the different modules available.

How it works

All modules inserted into the mainframe offer a variety of inputs and outputs that are managed by an internal routing matrix.

There are four converter slots equipped with eight channels per module and interface direction for conversion of up to 32 audio channels. Combined with the two audio network/multi-port MADI options, two single-port MADI options and the headphones outputs the maximum channel capacity of the device increases to 416 inputs and 420 outputs.

Signal processing is managed internally by a DSP routing matrix which connects hardware I/Os with the DSP processing blocks - such as Flex Channels, Matrix Mixer, Summing Busses and Plug-Ins (EQ, Delay, Dynamics).

Applications

PRODIGY.MP can be used for bidirectional conversion between analog and digital signals, signal processing, signal distribution, conversion between network audio formats, streaming audio, conversion between audio networks and MADI environments, conversion of different MADI signals.

Typical applications include:

- Live PA measurements, tuning and control
- Centralised virtual sound-check-station (collecting feeds from stage racks for multi-track recording, distribution of playback to different consoles with different formats and sample rates)
- Enhanced playback-station (with EARS and LTC reader)
- Signal collection and processing in broadcast and fixed installation (MicPres, EQs, Limiters, Delay, Summing Busses, Matrixes, Mixers, ...)
- Format and sample rate conversions of network audio streams
- Signal distribution (routing matrix)
- Clock extractor/distributor with automatic redundancy and selectable priorities
- Enhancing the level of redundancy of complex live and realtime audio environments
- Stream monitoring (headphones / hardware outputs)

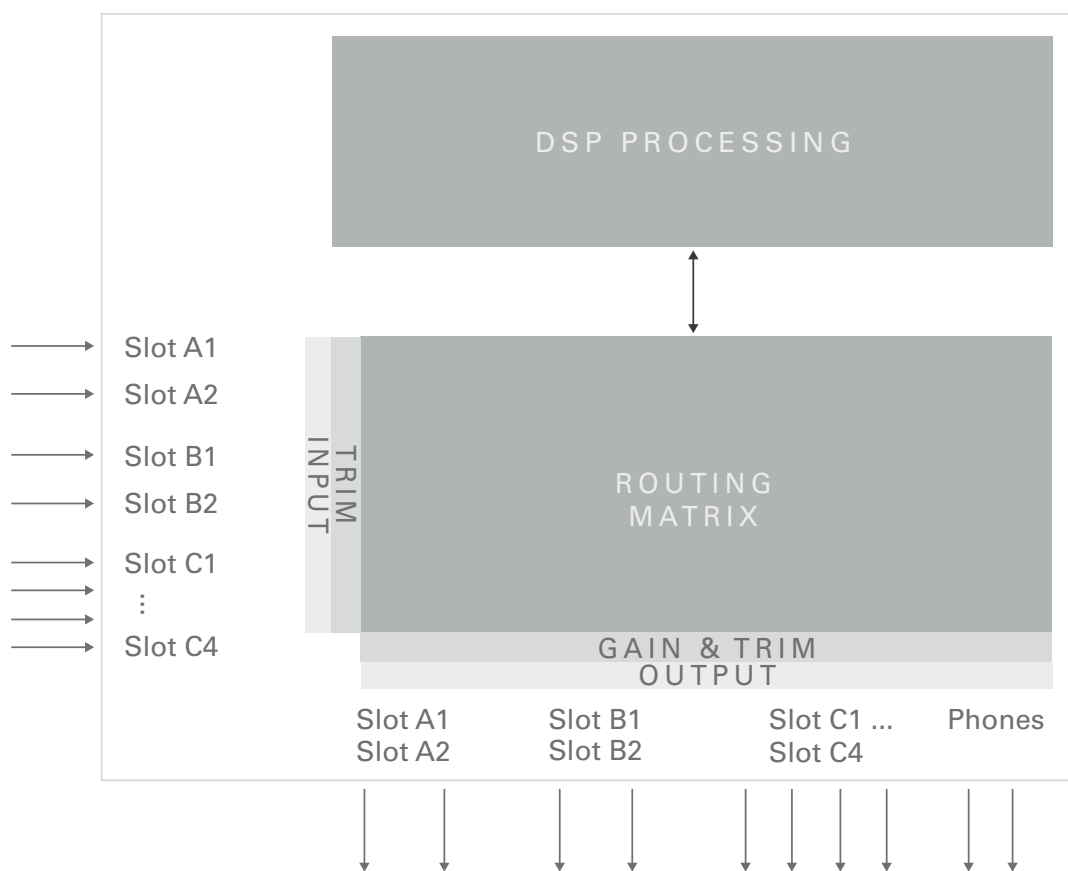
Scheme

Slots:

- Slot A - Audio Network / Multi-port MADI / USB Modules
- Slot B - Single-port MADI Modules
- Slot C - Converter Modules

CHAPTER 2: Legal issues & facts

Before Installing This Device



WARNING!

Please read and observe all of the following notes before installing this product:

- Check the hardware device for transport damage.
- Any devices showing signs of mechanical damage or damage from the spillage of liquids must not be connected to the mains supply, or disconnected from the mains immediately by pulling out the power lead.
- All devices must be grounded. The device is grounded through its IEC power connections.
- All devices must be connected to the mains using the three-cord power leads supplied with the system. Only supply electrical interfaces with the voltages and signals described in these instructions.
- Do not use the device at extreme temperatures. Proper operation can only be guaranteed between temperatures of 5° C and 45° C and a maximum relative humidity of 80 %, non-condensing.
- The cabinet of the device will heat up. Do not place the device close to heating sources (e.g. heaters). Observe the environmental conditions.

Defective Parts/Modules



WARNING!

This device contains no user-serviceable parts. Therefore do not open the device. In the event of a hardware defect, please send the device to your DirectOut representative together with a detailed description of the fault.

We would like to remind you to please check carefully whether the failure is caused by erroneous configuration, operation or connection before sending parts for repair.

First Aid (in case of electric shock)

WARNING!



- Do not touch the person or his/her clothing before power is turned off, otherwise you risk sustaining an electric shock yourself.
- Separate the person as quickly as possible from the electric power source as follows:
 - Switch off the equipment.
 - Unplug or disconnect the mains cable.
- Move the person away from the power source by using dry insulating material (such as wood or plastic).
- If the person is unconscious:
 - Check their pulse and reanimate if their respiration is poor.
 - Lay the body down and turn it to one side. Call for a doctor immediately.
- Having sustained an electric shock, always consult a doctor.

Updates

DirectOut products are continually in development, and therefore the information in this manual may be superseded by new releases. To access the latest documentation, please visit the DirectOut website:
www.directout.eu.

This guide refers to System Build 23.

Intended Operation

PRODIGY.MP is designed for signal processing / conversion / routing between analog, digital and audio network signals. Digital audio refers to AES3 and AES10 or USB Audio, audio network refers to Dante, AVB/MILAN, SoundGrid and RAVENNA (including AES67 and SMPTE ST 2110-30 /-31).



WARNING!

No compensation can be claimed for damages caused by operation of this unit other than for the intended use described above. Consecutive damages are also excluded explicitly. The general terms and conditions of business of DirectOut GmbH are applied.

Conditions of Warranty

This unit has been designed and examined carefully by the manufacturer and complies with actual norms and directives.

Warranty is granted by DirectOut GmbH over the period of 36 months for all components that are essential for proper and intended operation of the device. The date of purchase is applied for this period.

Consumable parts (e.g. battery) are excluded from warranty claims.



WARNING!

All claims of warranty will expire once the device has been opened or modified, or if instructions and warnings were ignored.

For warranty claims please contact the dealer where your device was acquired.

Conformity & Certificates

CE

This device complies with the basic requests of applicable EU guidelines. The appropriate procedure for approval has been carried out.

RoHS

(Restriction of the use of certain Hazardous Substances)

This device was constructed fulfilling the directive on the restriction of the use of certain hazardous substances in electrical and electronic equipment 2011/65/EU and 2015/863.

WEEE

(Directive on Waste Electrical and Electronic Equipment)

Due to the directive 2002/96/EC for waste disposal this device must be recycled.

For correct recycling please dispatch the device to:

DirectOut GmbH,
Hainichener Str. 66a
09648 Mittweida
Germany

Only stamped parcels will be accepted!

WEEE-Reg.-No. DE 64879540

Contact

DirectOut GmbH
Hainichener Str. 66a, 09648 Mittweida, Germany
Phone: +49 (0)3727 5650-00
Mail: sales@directout.eu
www.directout.eu

Contents

The contents of your PRODIGY.MP package should include:

- 1 x PRODIGY.MP (19", 2 RU)
- 2 x power chord with self locking mechanism
- 1 x Instruction Leaflet

The device provides slots for audio network modules, MADI modules and converter modules. The modules may be delivered separately and require installation first to complete the delivery.



TIP

Keep any packaging in order to protect the device should it need to be dispatched for service.

Remote Control

To access all functions of the device it is required to install the globcon remote control.

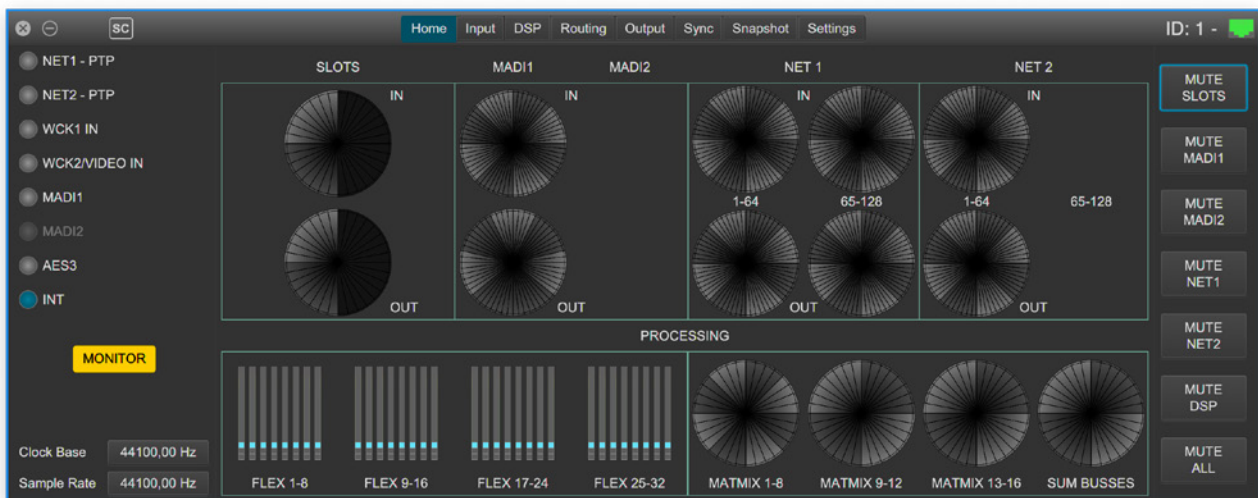

globcon is a free, global control software platform for the management of professional audio equipment. Almost all products of the DirectOut product portfolio are supported by globcon.

Link: www.globcon.pro

Accessories

BREAKOUT

The BREAKOUT series is a range of adaptor boxes available in different variants to extend the coverage of the ANDIAMO, MAVEN.A, PRODIGY.MC and PRODIGY.MP. They are equipped with XLR or BNC connectors on the front panel and DSUB-25 connectors on the rear panel. Audio signals are carried passively between the front and rear panels.

The small form factor and angle brackets also allow for mounting the devices on the back of an ANDIAMO or MAVEN or PRODIGY unit.



BREAKOUT.AN8 - analog input / output, 8 channels

Article code: DOBOB0889

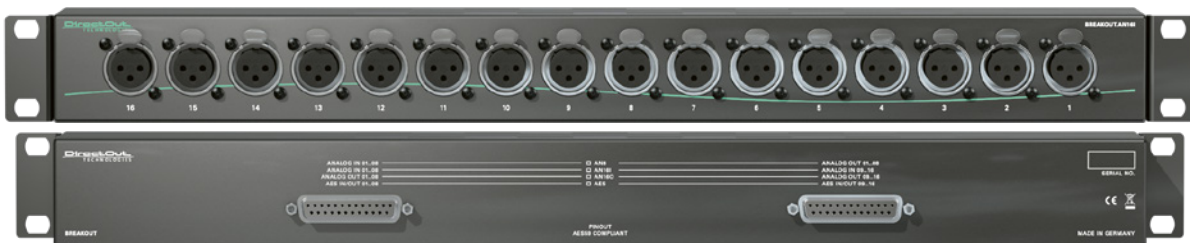

BREAKOUT.AN16I - analog input, 16 channels

Article code: DOBOB0890



BREAKOUT.AN16O - analog output, 16 channels

Article code: DOBOB0891

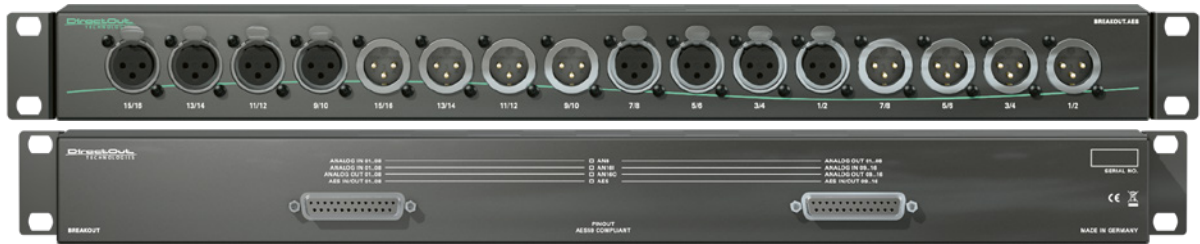

BREAKOUT.AES- digital input / output, 8 AES3 ports (16 channels)
Article Code: DOBOB0887

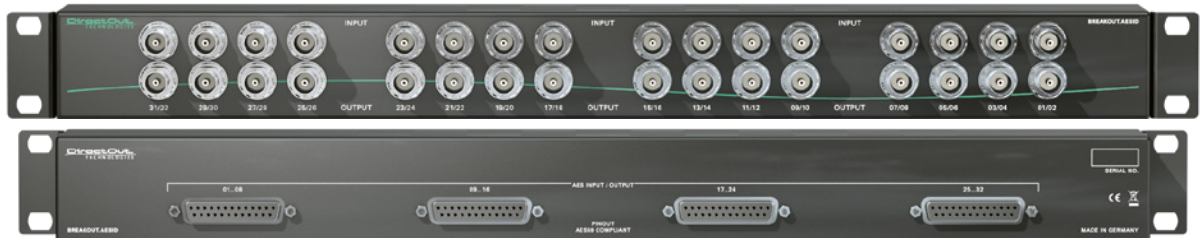

BREAKOUT.AESID- digital input / output, 16 AESid ports (32 channels)
Article Code: DOBOB0888

Patch Chords

Cabling from Cordial provides appropriate connection of the BREAKOUT with your device to ensure proper transmission of the audio signals.

Name	Description	Article code
DSUB25.AN50	Analog patch cable for connection with BREAKOUT.AN16I, AN16O, AN8, transferring 8 audio channels, length 0.5 m	DOCAA0334
DSUB25.AN100	Analog patch cable for connection with BREAKOUT.AN16I, AN16O, AN8, transferring 8 audio channels, length 1.0 m	DOCAA0335
DSUB25.AES50	Digital patch cable for connection with BREAKOUT.AES or AESid transferring 8 audio channels, length 0.5 m	DOCAA0332
DSUB25.AES100	Digital patch cable for connection with BREAKOUT.AES or AESid transferring 8 audio channels, length 0.5 m	DOCAA0333

SFP Transceiver - MAD1

Two different optical SFP transceiver for MAD1 transmission are available from DirectOut GmbH:

- Multi-mode SFP transceiver with LC connectors (No: DOICT0129)
- Single-mode SFP transceiver with LC connectors (No: DOICT0130)

Specification of the optical SFP transceivers:

SFP	Multimode	Singlemode
Wavelength TX nominal	1310 nm	1310 nm
Wavelength RX nominal	1310 nm	1310 nm
Distance	2 km	10 km
Powerbudget (dB)	> 11 dB	> 12 dB
Protocols	Fast Ethernet OC3/STM1	Gigabit Ethernet, Gigabit Fibre Channel
Bandwidth from	100 Mbit/s	1.050 Gbit/s
Bandwidth	155 Mbit/s	1.250 Gbit/s
Laser	FP	FP
Receiver Type	PIN	PIN
Connector	LC	LC
Wavelength TX min	1260 nm	1260 nm
Wavelength TX max	1360 nm	1360 nm
Wavelength RX min	1260 nm	1260 nm
Wavelength RX max	1620 nm	1600 nm
Transmit min	- 19.00 dBm	- 9.00 dBm
Transmit max	- 14.00 dBm	- 3.00 dBm
Receive min	- 30 dBm	- 21.00 dBm
Receive max (Receiver overload)	- 5.00 dBm	- 3.00 dBm
Temperature (min)	0° Celsius	0° Celsius
Temperature (max)	70° Celsius	70° Celsius
Type of DDM/DOM	internal	internal
Extinction Ratio	8.20 dB	9 dB

SFP Transceiver - Network

Two different optical SFP transceiver for 1Gbit/s ethernet transmission are available from DirectOut GmbH:

- SFP Copper Transceiver, RJ-45 (No: DOICT0132)
- SFP Optical Transceiver, optical LC Single Mode (No: DOICT0133)

Specification

SFP	Copper - RJ45	Optical - LC single mode
Distance	100 m via CATe cable	2000 m
Wavelength	-	1310 nm
Datarate	12 Mbit/s to 1.25 Gbit/s	2.67 GBit/s

This page is left blank intentionally.

CHAPTER 3: Installation

Installing the Device

1. Open the packaging and check that the contents have been delivered complete and undamaged.
2. Fix the device in a 19" frame with four screws, or place it on a non-slip horizontal surface.



WARNING!

Avoid damage from condensation by waiting for the device to adapt to the environmental temperature. Proper operation can only be guaranteed between temperatures of 5° C and 45° C and a maximum relative humidity of 80%, non-condensing.

Ensure that the unit has sufficient air circulation for cooling.

Do not cover the fan outlets and the slots at the sides of the device!

Do not block the fans by putting objects through the protective grid!



3. For installation of separately delivered modules follow the instructions in the manual enclosed with the packaging of the modules.



1	A Slots - see page 32
2	B Slots - see page 44
3	C Slots - see page 48

4. Connect the signal cables with the installed modules. For more details about connecting audio network, MADI, AES3 and analog signals see „Slots- Connecting Audio“ on page 31.
5. Connect a network cable to PORT 1,2 or 3 of the MANAGEMENT sockets to control the device via network.



6. Using the power cord provided connect the PSUs to a matching power supply.



The delivered power cords provide a self-locking mechanism to prevent an accidental disconnect. To unlock the connection press the red release mechanism.



WARNING!



This device must be connected to the mains using the three-core power leads supplied with the system. Only supply the voltages and signals indicated (84 V – 264 V).

7. Turn on the power switches:



Check the display on the front panel for warnings.

8. Enter `http://<IP Address>` (default IP: DHCP) in the navigation bar of your browser to open the control website. The IP address is assigned by the DHCP server of your network and can be checked or altered on the display at the front panel.

9. Install globcon on your computer
To access all functions the use of globcon is required - see page 16.

10. Launch globcon control
Select the port of the network where your device is connected to
Sidebar - My Devices - Click Discovery Methods
and set Ethernet Discovery to 'ON'

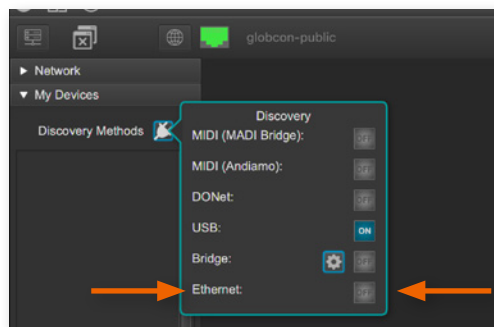

Select the device from the list and click 'Add'

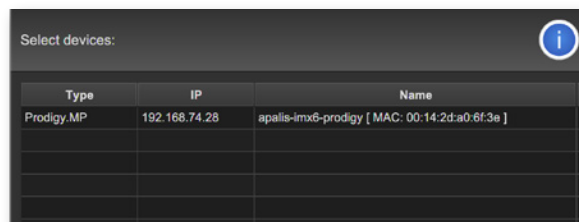

Confirm your selection with 'OK'

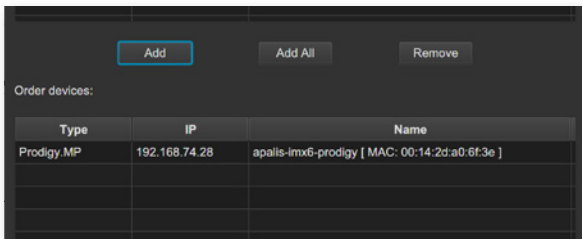

The device is displayed in the overview of globcon. Double-Click the tiny display of the device to open the control.



More information and video tutorials about globcon are available at www.globcon.pro.

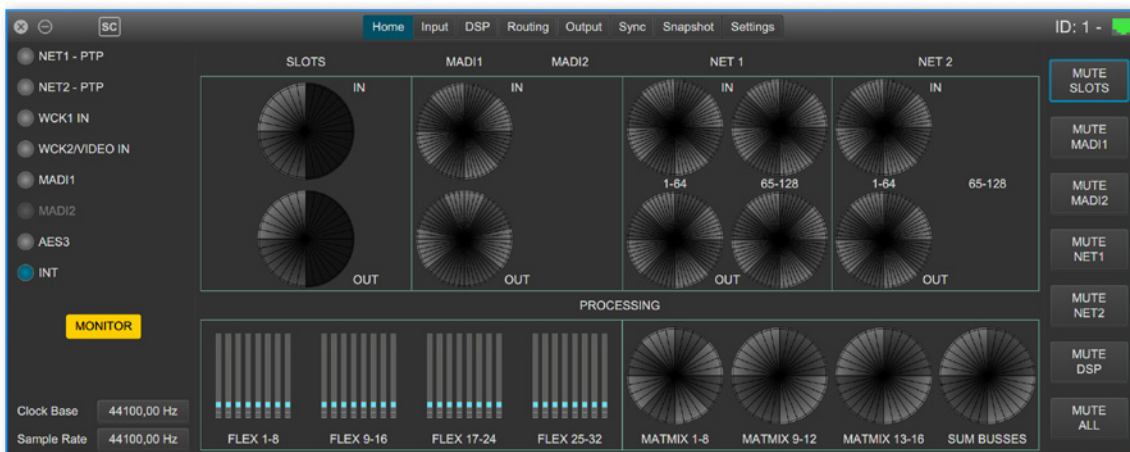

NOTE



For globcon control of the device the network infrastructure is required to have ports 5002, 5003 and 5004 unfiltered for TCP traffic. Since the device discovery uses multicast-DNS (mDNS), the device may be discovered but cannot be controlled if the ports 5002, 5003 and 5004 are filtered.

CHAPTER 4: Operation

Introduction

This chapter describes the basic operation of the device.

Note that throughout this manual, the abbreviation FS refers to sample rate or sample frequency. So, when dealing with scaling factors, the following sample rates can be written as:

- 44.1 kHz or 48 kHz = 1 FS
- 88.2 kHz or 96 kHz = 2 FS
- 176.4 kHz or 192 kHz = 4 FS

Global Control

The display on the front panel indicates the power supply. The power switches are on the back panel:



PSU 1 & PSU 2	2 Switches Enable / disable power supply.
PSU 1 & PSU 2	2 C13 sockets Connect the power supply here (84- 264 V AC).

WARNING



Before switching off the power supply, the system must be shut down first - see "Shutdown" on page 81.



POWER PSU 1 & PSU 2	LED RGB - indicates state of power supply <ul style="list-style-type: none"> <input type="radio"/> (OFF) = power supply not working <input checked="" type="radio"/> (ON, green) = power supply working <input checked="" type="radio"/> (blinking, red) = power supply was active and is now inactive.
-------------------------------	--

NOTE



The green LEDs (PSU 1 & PSU 2) indicate that a working power supply is connected to the power supply unit. Note that an unlit LED does not guarantee that the device is free of voltage. To ensure that the device is completely disconnected from mains voltage, the power chords must be disconnected.

Managing Device

The device is equipped with a touch-display, an encoder and two push buttons for local control. For remote operation a network socket is provided at the rear panel to operate the device via a browser based GUI or via globcon.

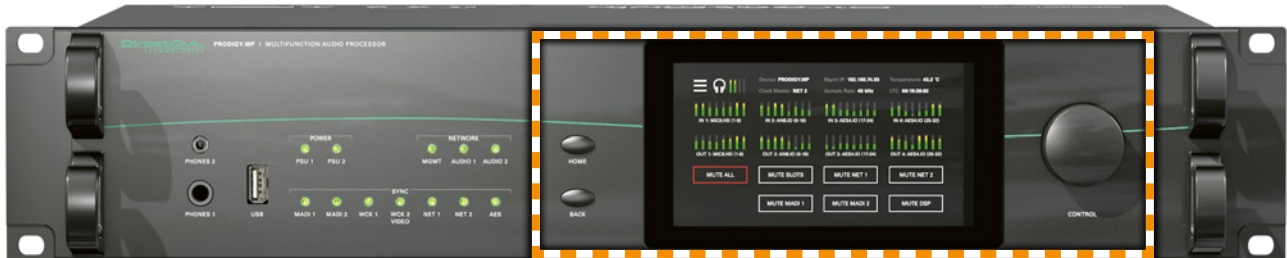





HOME	Push-button to access the HOME screen. Press shortly to call the top menu.
BACK	Push-button to return to previous page. Press shortly to return to the previous page.
Display	Touch-Display to navigate the menu, adjust settings and for monitoring. tap, swipe- have fun!
CONTROL	Encoder to adjust values and confirmation. Rotate to modify values. Press to confirm a setting.

Networking

PRODIGY.MP uses separate network links for managing the device and network-audio transmission. LEDs on the front panel indicate the state of all network links.



MANAGEMENT 1	2 x RJ 45 socket & SFP slot Connect here for network control and firmware updates.
MANAGEMENT PORT 1 & 2	LED orange - indicates the link state of the network connection.  (ON) = device link active  (OFF) = device link not active
MANAGEMENT PORT 1 & 2	LED green - indicates the activity state of the network connection.  (ON) = data sent or received  (OFF) = no data transmission
AUDIO NETWORK 1 AUDIO NETWORK 2 2	Option Slots (A) for audio network or multi-port MADI modules See „Slot A- Audio Network, Multi-Port MADI, USB“ on page 32.



<p>NETWORK MGMT</p>	<p>LED - indicates the state of the controller for management.</p> <ul style="list-style-type: none"> ○ (OFF) = controller not available ● (ON) = controller ready ● (ON, blue) = controller shut down, device is ready to be switched off**
<p>NETWORK AUDIO 1 & AUDIO 2</p>	<p>LED - indicates the state of the network audio modules.</p> <ul style="list-style-type: none"> ○ (OFF) = network module not ready ● (ON) = network module ready ● (blinking, red) = network module in panic mode*

* please contact support@directout.eu

** to ensure proper file operation a shut down must be initiated before switching the device off - see "Shutdown" on page 81.

Slots - Connecting Audio

PRODIGY.MP offers three different slot-types that can be populated individually according to the particular requirements.



Slot A 1	2 x Option slot for audio network or multi-port MADI or USB Modules See „Slot A- Audio Network, Multi-Port MADI, USB“ on page 32
Slot B 2	2 x Option slot for single-port MADI Modules See „Slot B- Single-Port MADI“ on page 44
Slot C 3	4 x Option slot for Converter Modules See „Slot C- Converter AD/DA, Mic, AES3“ on page 48

WARNING!



All module slots must be fitted with a module or a blind plate each. Otherwise live parts become accessible which may cause serious harm to your health. An open housing may also cause inappropriate operation conditions due to an insufficient electromagnetic shielding.

Slot A - Audio Network, Multi-Port MADI, USB

Modules for A Slots connect with different audio networks or MADI or USB. Four audio network protocols (Dante, RAVENNA, SoundGrid, AVB/MILAN) are supported. The multi-port MADI modules are available in variants with two or four MADI ports (see p 39). The USB.IO module interfaces with computer-based production systems (see p 42).

Audio Network

Each module is equipped with 1 x SFP and 2 x RJ45-sockets (Gigabit-Ethernet).

Module	Protocol	Capacity	SRC*
DANTE.IO	Dante / AES67	64 ch in / out	no <input type="checkbox"/> SRC
DANTE.SRC.IO	Dante / AES67	64 ch in / out	yes <input checked="" type="checkbox"/> SRC
RAV.IO	RAVENNA / AES67 / SMPTE ST 2110-30 /-31	128 ch in / out	no <input type="checkbox"/> SRC
RAV.SRC.IO	RAVENNA / AES67 / SMPTE ST 2110-30 /-31	128 ch in / out	yes <input checked="" type="checkbox"/> SRC
SG.IO	SoundGrid	128 ch in / out	no <input type="checkbox"/> SRC
SG.SRC.IO	SoundGrid	128 ch in / out	yes <input checked="" type="checkbox"/> SRC
MILAN.IO	AVB / MILAN	128 ch in / out	no <input type="checkbox"/> SRC
MILAN.SRC.IO	AVB / MILAN	128 ch in / out	yes <input checked="" type="checkbox"/> SRC

* The SRC versions are equipped with a bidirectional sample rate converter (HD SRC).

They are marked with a dot on the module plane.

DANTE.IO
DANTE.SRC.IO

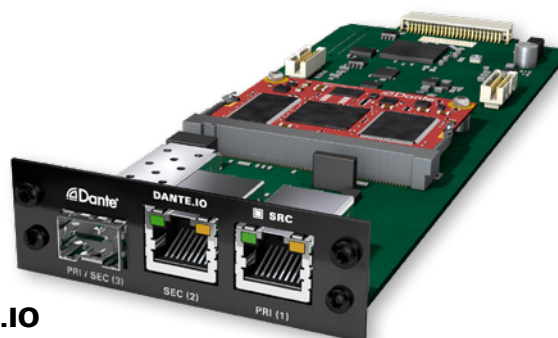

RAV.IO
RAV.SRC.IO

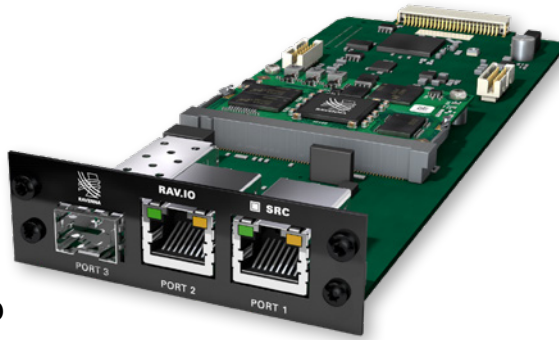

SG.IO
SG.SRC.IO

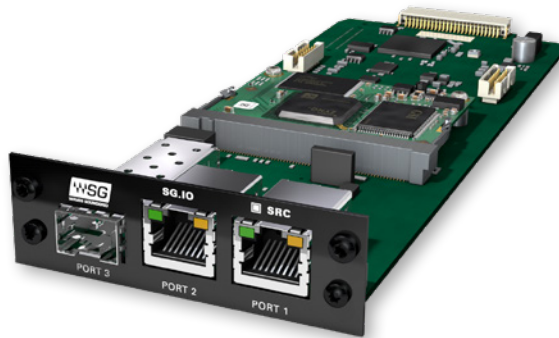

MILAN.IO
MILAN.SRC.IO

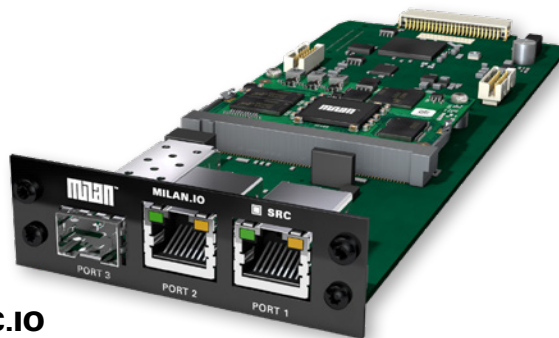



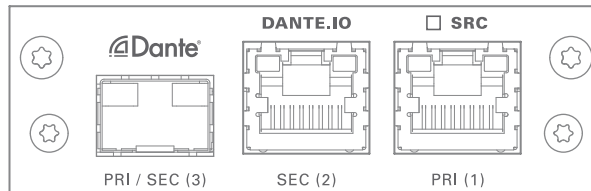

DANTE.IO / DANTE.SRC.IO

Three network ports are available for transmission of audio signals (Dante / AES67). The built-in network switch can be operated in three modes:

- Switched (all ports in the same network)
- Redundant (1 = Primary, 2 = Secondary, 3 = Primary)
- Red_Sec (1 = Primary, 2 & 3 = Secondary)



The switch will be configured automatically by selecting the respective operation mode in Dante Controller.

PRI (1)	RJ45 socket (1 Gbit/s) Network interface - connect here for network transmission. Primary Port when used in redundant operation.
SEC (2)	RJ45 socket (1 Gbit/s) Network interface - connect here for network transmission. Secondary Port when used in redundant operation.
PRI (1) SEC (2)	LED orange - indicates the link state of the network connection.  (ON) = device link active  (OFF) = device link not active
PRI (1) SEC (2)	LED green - indicates the activity state of the network connection.  (ON) = data sent or received  (OFF) = no data transmission
PRI / SEC (3)	SFP cage Insert SFP transceiver here and connect to the network.* Primary or secondary (selectable) port when used in redundant operation.

* See page 20 for SFP-transceiver that are available by DirectOut.



NOTE

If redundancy is being used, secondary interfaces should be connected to a second separate network. Secondary interfaces cannot communicate with primary interfaces.

RAV.IO / RAV.SRC.IO

Three network ports are available for transmission of audio signals (RAVENNA / AES 67 / SMPTE 2110-30 / -31). The module supports Seamless Protection Switching according to SMPTE 2022-7.

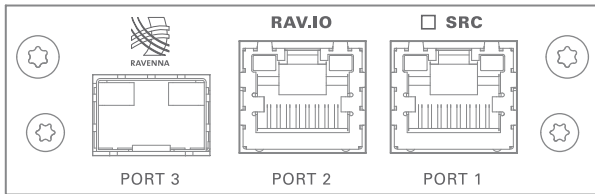

PORT 1 PORT 2	RJ45 socket (1 Gbit/s) Network interface - connect here for network transmission.
PORT 1 PORT 2	LED orange - indicates the link state of the network connection. ■ (ON) = device link active ■ (OFF) = device link not active
PORT 1 PORT 2	LED green - indicates the activity state of the network connection. ■ (ON) = data sent or received ■ (OFF) = no data transmission
PORT 3	SFP cage Insert SFP transceiver here and connect to the network.*

* See page 20 for SFP-transceiver that are available by DirectOut.

The configuration of the built-in network switch is available via the browser interface of the RAV.IO-module.

NOTE





Further devices that require PTP synchronisation should be connected to an external PTP-aware switch.

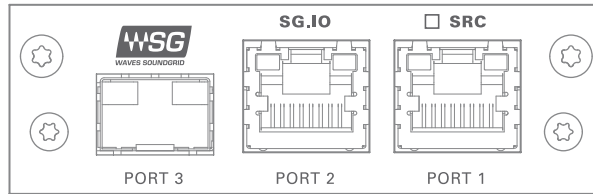

SG.IO / SG.SRC.IO

Three network ports are available for transmission of audio signals (SoundGrid).







PORT 1 PORT 2	RJ45 socket (1 Gbit/s) Network interface - connect here for network transmission.
PORT 1 PORT 2	LED orange - indicates the link state of the network connection.  (ON) = device link active  (OFF) = device link not active
PORT 1 PORT 2	LED green - indicates the activity state of the network connection.  (ON) = data sent or received  (OFF) = no data transmission
PORT 3	SFP cage Insert SFP transceiver here and connect to the network.*

* See page 20 for SFP-transceiver that are available by DirectOut.

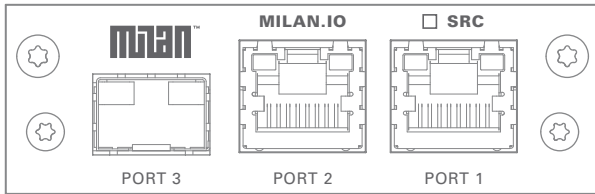
MILAN.IO / MILAN.SRC.IO

Three network ports are available for transmission of audio signals (AVB / MILAN).



PORT 1 PORT 2	RJ45 socket (1 Gbit/s) Network interface - connect here for network transmission.
PORT 1 PORT 2	LED orange - indicates the link state of the network connection.  (ON) = device link active  (OFF) = device link not active
PORT 1 PORT 2	LED green - indicates the activity state of the network connection.  (ON) = data sent or received  (OFF) = no data transmission
PORT 3	SFP cage Insert SFP transceiver here and connect to the network.*

* See page 20 for SFP-transceiver that are available by DirectOut.

The configuration of the built-in network switch is available via the browser interface of the RAV.IO-module.

This page is left blank intentionally.

Multi-port MADI

The multi-port MADI modules extend the number of MADI ports of a PRODIGY or MAVEN. The SRC versions are equipped with a bidirectional sample rate converter (HD SRC).

Module	MADI ports	Connector	Capacity	SRC
MADI2.SRC.IO	2	2 x SFP	128 ch in / out	HD SRC
MADI2.BNC.SRC.IO	2	4 x BNC	128 ch in / out	HD SRC
MADI4.IO	4	4 x SFP	256 ch in / out	-
MADI4.SRC.IO	4	4 x SFP	256 ch in / out	HD SRC

Compatibility

Module	PRODIGY. MC	PRODIGY. MP	PRODIGY. MX	MAVEN.A
MADI2.SRC.IO	•	•	•	•
MADI2.BNC.SRC.IO	•	•	•	•
MADI4.IO	no	no	•	•
MADI4.SRC.IO	no	no	•	•

NOTE

At this time (January 2025) the MADI4.IO and MADI4.SRC.IO are compatible only with PRODIGY.MX and MAVEN.A.



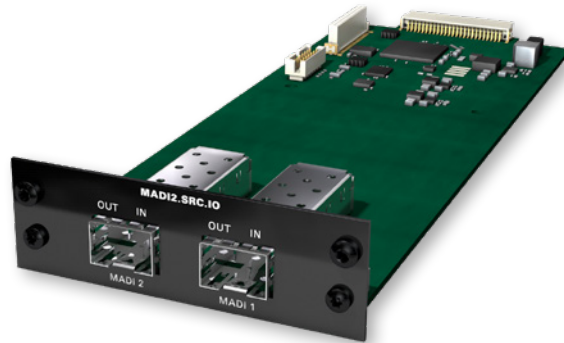

MADI2.SRC.IO



MADI2.BNC.SRC.IO

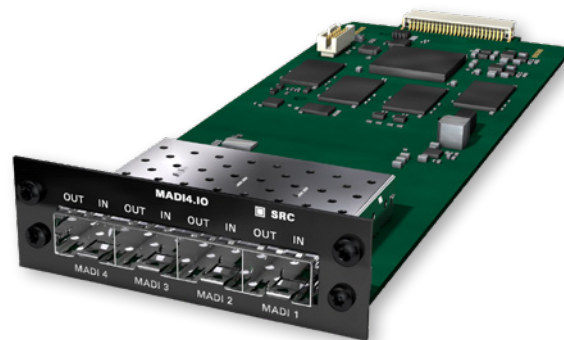

MADI4.IO
MADI4.SRC.IO
(PRODIGY.MX, MAVEN.A only)

MADI2.SRC.IO

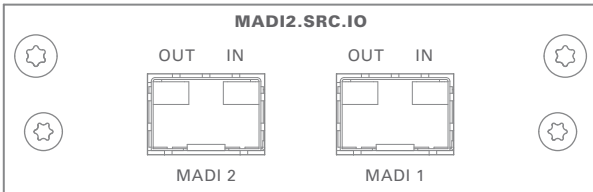

SFP

2 x SFP cage

Insert SFP transceiver(s) here and connect MADI input/output.

MADI2.BNC.SRC.IO

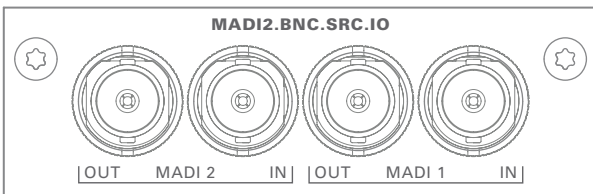

BNC

2 x BNC socket (coaxial)*

OUT: MADI output, connect for MADI output signal here.

IN: MADI input, connect MADI input signal here

MADI4.IO / MADI4.SRC.IO (PRODIGY.MX, MAVEN.A only)

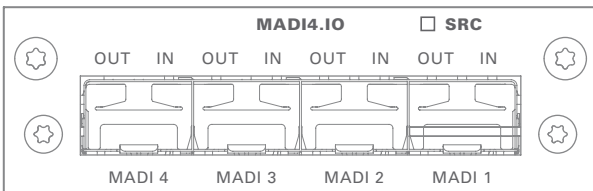

SFP

4 x SFP cage

Insert SFP transceiver(s) here and connect MADI input/output.

USB Audio



USB.IO

USB.IO

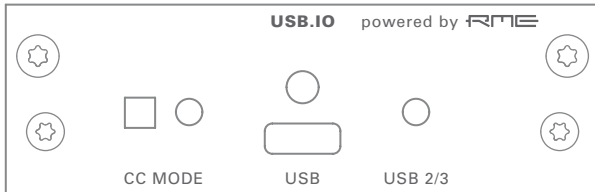

USB	<p>1 x USB-C socket for audio transmission Connect with USB 3.0 or 2.0 port</p>
CC MODE	<p>Push button Press to toggle operating mode. Restart of the module or dis- / reconnect of the USB connection is required after change.</p>
CC MODE	<p>LED orange - indicates operation mode <input type="radio"/> (OFF) = CC mode OFF <input checked="" type="radio"/> (ON, orange) = CC mode ON</p>
USB	<p>USB-C socket for audio transmission Connect with USB 3.0 or 2.0 port</p>
USB 2/3	<p>LED RGB - indicates USB connection <input checked="" type="radio"/> (ON, blue) = USB 3.0 (128 channels) <input checked="" type="radio"/> (ON, yellow) = USB 2.0 (64 channels) <input checked="" type="radio"/> (ON, red) = no USB connection</p>

Slot B - Single-Port MADI

Modules for B Slots connect single-port MADI modules.

Three connection standards for transmission of 64 channels @ 1 FS are offered.

For extended MADI connectivity there are multi-port MADI modules that fit into the A Slots (see p 39).

Module	Connection
BNC.IO	coaxial BNC input / output 75 Ω
SFP.IO	SFP cage *
SC.IO	SC-socket duplex multi-mode **

* matching SFP transceiver are available from DirectOut - see page 19.

** The SC ports are multi-mode as default, single-mode SC ports are available on request. The housing of single-mode ports is colored blue.



multi-mode

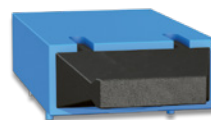

single-mode

Single-port MADI

BNC.IO



SC.IO

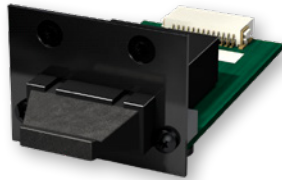

SFP.IO



BNC.IO

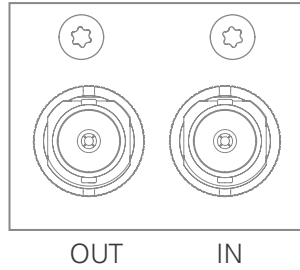

BNC	<p>2 x BNC socket (coaxial)*</p> <p>OUT: MAD I output, connect for MAD I output signal here.</p> <p>IN: MAD I input, connect MAD I input signal here</p>
-----	---

* The labelling of the MAD I ports (Slot B) is printed on the mainframe.

SC.IO

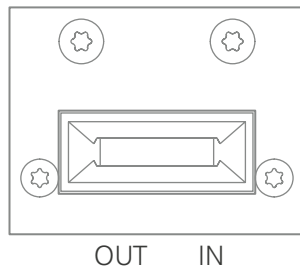

SC	<p>2 x SC socket (optical)*</p> <p>OUT: MAD I output, connect for MAD I output signal here.</p> <p>IN: MAD I input, connect MAD I input signal here</p>
----	--

* The labelling of the MAD I ports (Slot B) is printed on the mainframe.

SFP IO

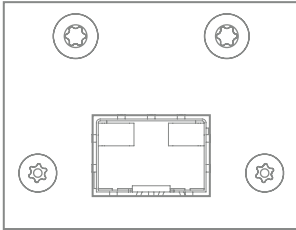

OUT IN

SFP	SFP cage Insert SFP transceiver here and connect MADI input/output.
-----	---

* The labelling of the MADI ports (Slot B) is printed on the mainframe.

Slot C - Converter AD/DA, Mic, AES3

The C Slots can be equipped with analog or digital modules. The pin-out of the DSUB-25 sockets is according to AES59 ('Tascam').

Analog Modules

Module	Input	Output
AN8.O		8 ch line out
AN8.IO	8 ch line in	8 ch line out
AN8.I	8 ch line in	
MIC8.HD.I	8 ch mic input (HD)	
MIC8.HD.IO	8 ch mic input (HD)	8 ch line out
MIC8.LINE.IO	8 ch mic input	8 ch line out
MIC8.LINE.I	8 ch mic input	

AN8.O



AN8.IO



AN8.I



MIC8.HD.I



MIC8.HD.IO



MIC8.LINE.IO



MIC8.LINE.I



Reference Level

The analog reference level of line inputs and outputs can be adjusted via jumper - for each channel individually. Check the label on the particular board. At modules with two boards the input is at the bottom and the pins are accessed from the side, where as the output is at the top and the pins are accessed from the top.

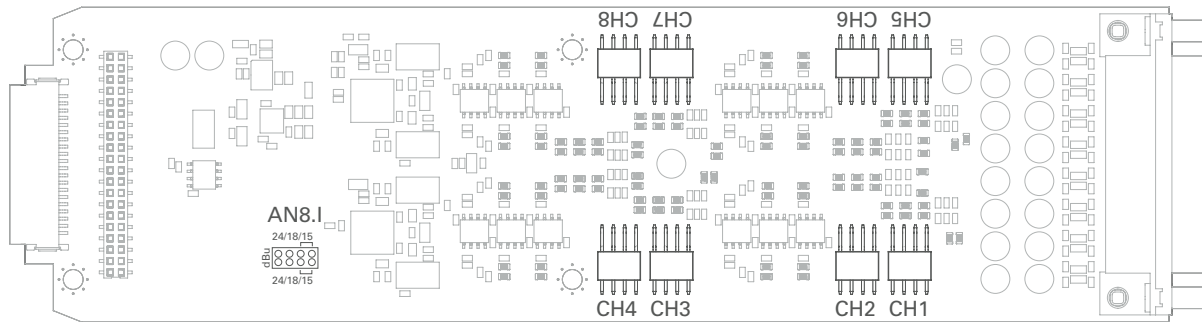

AN8.I - access from sideways

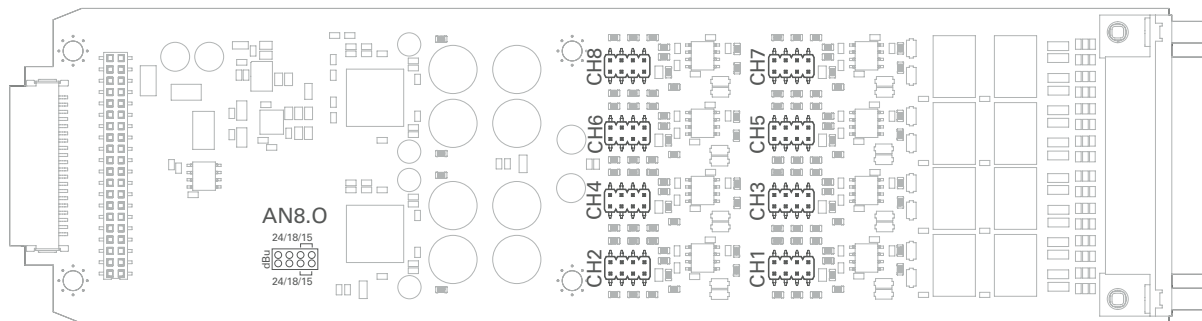

AN8.O - access from top

Level Settings

15 dBu

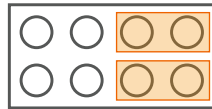

18 dBu

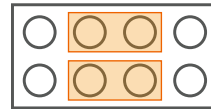

24 dBu

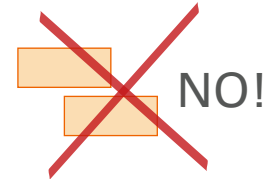
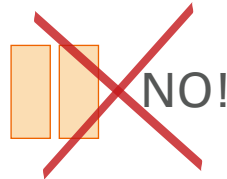
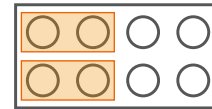

WARNING

To prevent damage from the board only set the jumpers parallel in horizontal direction - as illustrated above.



NOTE

The pinout of the digital and analog I/O is different. Check for appropriate cabling to ensure proper operation and to avoid damages caused by improper connections.

The analog outputs are fed by the D/A converters and not a split-out of the analog inputs.



WARNING

Do not connect voltage sources to the analog outputs. This may cause damage at the output stages. Observe the technical specifications listed in this document.



WARNING

The line output is not servo balanced. Do not connect the negative lead to ground. This may cause damage at the output stage. Observe the technical specifications listed in this document.

AN8.O

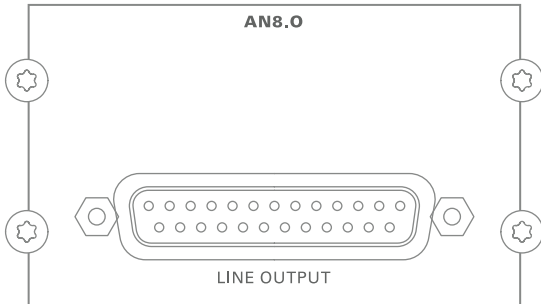

LINE OUTPUT	DSUB-25 Port (analog pinout) Analog audio output (balanced) - connect for line level audio here
-------------	--

AN8.IO

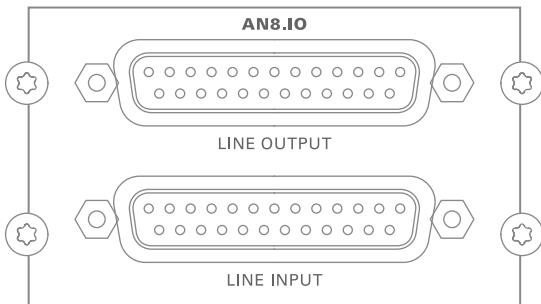

LINE OUTPUT	DSUB-25 Port (analog pinout) Analog audio output (balanced) - connect for line level audio here
LINE INPUT	DSUB-25 Port (analog pinout) Analog audio input (balanced) - connect line level audio source here

The pinout complies with AES59 ('TASCAM pinout') - see „Appendix A- DSUB-25 Pin assignment“ on page 70.

AN8.I

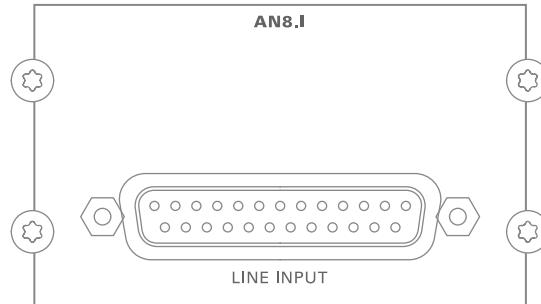

LINE INPUT	<p>DSUB-25 Port (analog pinout) Analog audio input (balanced) - connect line level audio source here</p>
------------	---

MIC8.HD.I

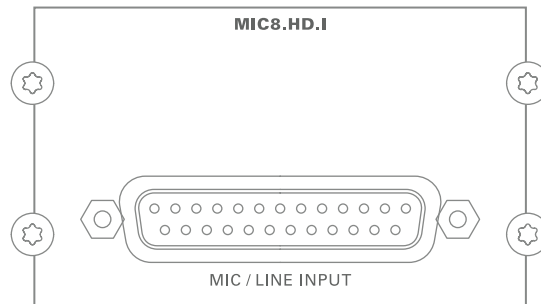

MIC / LINE INPUT	<p>DSUB-25 Port (analog pinout) Analog audio input (balanced) - connect mic / line level audio source here</p>
------------------	---

The pinout complies with AES59 ('TASCAM pinout') - see „Appendix A- DSUB-25 Pin assignment“ on page 70.

MIC8.HD.IO

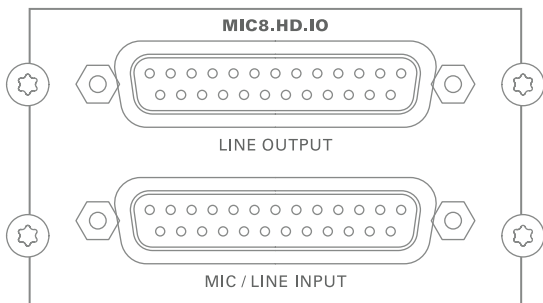

LINE OUTPUT	DSUB-25 Port (analog pinout) Analog audio output (balanced) - connect for line level audio here
MIC / LINE INPUT	DSUB-25 Port (analog pinout) Analog audio input (balanced) - connect mic / line level audio source here

MIC8.LINE.IO

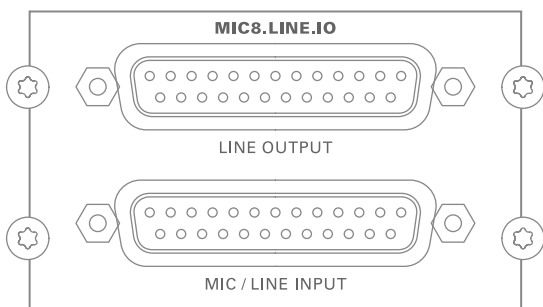

LINE OUTPUT	DSUB-25 Port (analog pinout) Analog audio output (balanced) - connect for line level audio here
MIC / LINE INPUT	DSUB-25 Port (analog pinout) Analog audio input (balanced) - connect mic / line level audio source here

The pinout complies with AES59 ('TASCAM pinout') - see „Appendix A- DSUB-25 Pin assignment“ on page 70.

MIC8.LINE.I

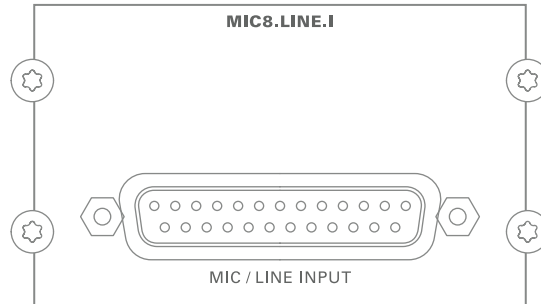

MIC / LINE INPUT	DSUB-25 Port (analog pinout) Analog audio input (balanced) - connect mic / line level audio source here
------------------	--

The pinout complies with AES59 ('TASCAM pinout') - see „Appendix A- DSUB-25 Pin assignment“ on page 70.

Digital Modules

Module	Input	Output
AES4.IO	4 port AES3 in	4 port AES3 out
AES4.SRC.IO	4 port AES3 in with SRC	4 port AES3 out

AES4.IO



AES4.SRC.IO



NOTE

An AES4.IO transports eight audio channels - two audio channels per port.



AES4.IO

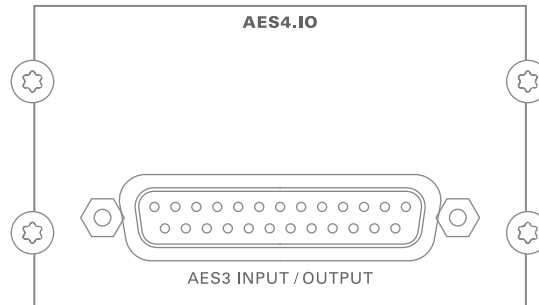

AES3 INPUT / OUTPUT	<p>DSUB-25 Port (digital pinout) Digital audio input and output (AES3) - connect for digital audio here</p>
---------------------	--

AES4.SRC.IO

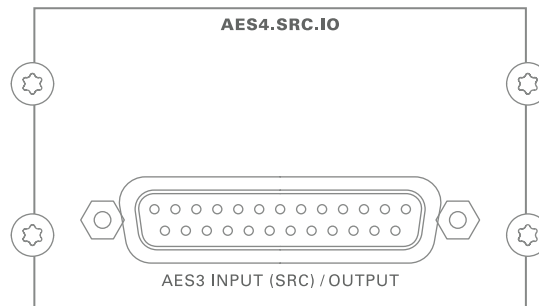

AES3 INPUT (SRC) / OUTPUT	<p>DSUB-25 Port (digital pinout) Digital audio input and output (AES3) - connect for digital audio here. Input offers switchable Sample Rate Conversion.</p>
---------------------------	---

The pinout complies with AES59 ('TASCAM pinout') - see „Appendix A- DSUB-25 Pin assignment“ on page 70.

This page is left blank intentionally.

Word clock

Two word clocks inputs and outputs are available. The word clock output provides the system clock that is either derived from PTP / Network Audio input, AES input, word clock input, MAD1 input or internal clock generator. WCK 2 input may be switched to video sync.



WCK 1 OUT	BNC socket (coaxial), 75 Ω System clock output - connect for word clock output signal here.
WCK 1 IN	BNC socket (coaxial), 75 Ω Connect word clock or AES3 DARS (Digital Audio Reference Signal) here.
WCK 2 OUT	BNC socket (coaxial), 75 Ω Word clock output - connect for secondary word clock output signal here.
WCK 2 IN	BNC socket (coaxial), 75 Ω Connect secondary word clock or AES3 DARS (Digital Audio Reference Signal) or video signal here.

Both word clock inputs also accept a AES3 frame (AES11).

When switched to video sync, the WCK 2 input accepts black burst or tri-level sync.

Termination (75 Ω) for the word clock inputs is switchable locally or via remote control.

Clocking

The device offers several options for clocking.

- PTP (Precision Time Protocol) - IEEE1588-2008 / PTPv 1 & 2 *
- SoundGrid (SoE) *
- AVB *
- USB *
- Word Clock / Video
- MADI input *
- AES3 input *
- internal clock generator

* depending on the modules installed.

When PTP (network) is selected the device can either act as slave or as network grandmaster. The front panel informs about selected clock sources and their lock / sync state.



<p>SYNC</p> <p>MADI 1 MADI 2 WCK 1 WCK 2 / VIDEO NET 1 NET 2 AES</p>	<p>LED RGB - indicates the lock / sync state of MADI input, of the modules hosted in A slots, word clock or AES3 input.</p> <p>○ (OFF) = no signal lock</p> <p>● (ON, green) = signal lock, in sync</p> <p>● (ON, blue) = signal lock, in sync, selected clock source</p> <p>● (ON, yellow) = signal lock, sample rate conversion active</p> <p>● (blinking, green) = signal lock, not in sync with selected clock source</p> <p>● (blinking, red) = input selected as clock source and no signal lock.</p>
---	--

About the multi-port MADI modules

(MADI2.SRC.IO, MADI2.BNC.SRC.IO)

- The MADI ports operate independently from each other.
- Each port can be selected as clock source in globcon.
- Sample rate conversion is switchable for each port, input and output individually
- Scaling factor may adjusted individually for each port.

USB

Two USB ports at the front and rear panel are used for legacy control of ANDIAMO devices via globcon bridge.



USB

(front / rear)

USB 2.0 socket (Type A)

Connect here for legacy control.



NOTE

The local USB ports are not used for audio transmission. To interface with an USB audio transmission the Slot A needs to be populated with an USB.IO module-see "USB.IO" on page 42.

MIDI

PRODIGY.MP offers MIDI control to either trigger device functions (input) or to control external equipment via globcon (output).



MIDI

OUT / IN

2 x DIN 5-pin connector

OUT: MIDI output, connect for MIDI output signal here.

IN: MIDI input, connect MIDI input signal here.

GPIO

General Purpose Input and Output

Two MOSFET switches (2 x GPO) can be triggered. A power supply (12 V, max. 200 mA) is also provided. This allows to remote control external devices; e.g. a recording light.

Two GPIs can be triggered by connecting the input pin with ground (GND) or by a voltage source between input pin and ground. The high level of the voltage may range between 2 V and 30 V due to a safety limiter in the input.



GPIO

DSUB-9 socket (female)

Connect for GPIO application here.

Observe the pin out - see „Appendix B- DSUB-9 Pin assignment“ on page 101.

CHAPTER 5: Managing Device

Introduction

PRODIGY.MP can be managed via multiple user interfaces:



- local touch display on the front panel

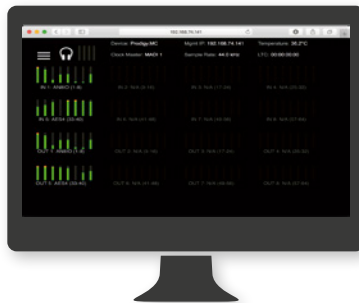

- browser based control / website



- globcon control

Further a JSON API (JavaScript Object Notation) is available for management.

This documentation explains the management via touch-display and browser control. For the use of globcon control there are video tutorials available that can be found at www.globcon.pro.

Getting started

1. Check the hardware - the housing must be closed completely.
Empty slots require covering with a blank plate.
2. Check network connection with one of the three MGMT ports on the rear panel.



3. Check the power cabling and switch on the device.



4. After the boot process of the device is complete. Check the display on the front panel for the IP address.



NOTE

The device will look for a DHCP server in the network to obtain its IP address. However the IP address can be changed manually via the touch display - see "NETWORK" on page 78.



Local operation

The device is equipped with a touch-display, an encoder and two push buttons for local control. For remote operation a network socket is provided at the rear panel to operate the device via a browser based GUI or via globcon control.



HOME	Push-button to access the HOME screen. Press shortly to call the top menu.
BACK	Push-button to return to previous page. Press shortly to return to the previous page.
Display	Touch-Display to navigate the menu, adjust settings and for monitoring. tap, swipe- have fun!
CONTROL	Encoder to adjust values and confirmation and for volume control of the phones outputs. Rotate to modify values. Push to confirm a setting or to zero a value. Phones volume control - active in HOME view: push to enter volume control or to toggle the selection between PHONES 1 and PHONES 2. Rotate to modify values. Automatic timeout of the control display is about 5 seconds.



NOTE

For remote operation via browser, enter the IP-Address in the navigation bar of your browser. Local and remote display are identical.

For remote operation via globcon control, you need to install globcon on your computer first - see page 16. Then follow the steps described in "CHAPTER 3: Installation" on page 22.

MAIN MENU

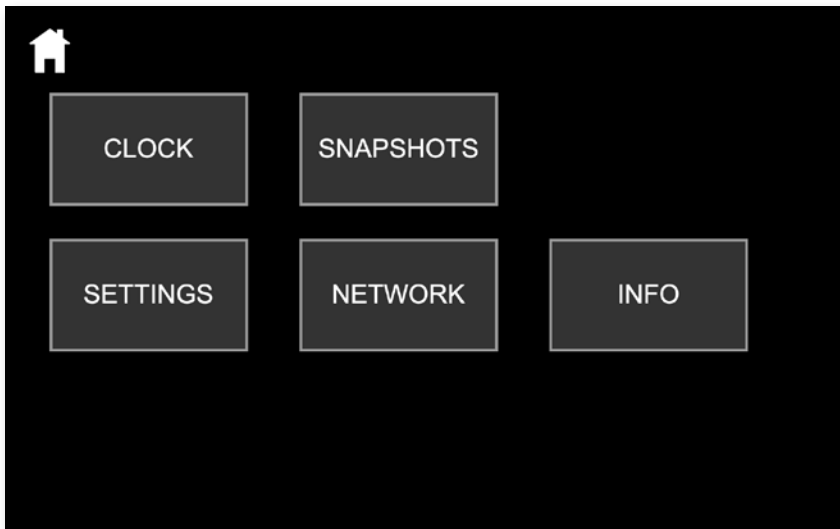

The MAIN MENU displays:

- Icons to access the HOME menu and further settings

Tap / click	to open
Home icon	HOME Menu
Clock	Clock Settings
Snapshots	Snapshot list for recall
Settings	Device Settings, Auto Lock, Screen Saver, Reboot to Update Mode, Shutdown, Reboot Device
Network	Network Settings for the Management Ports
Info	Display of Device Name, System Build, FPGA Version, cored version, Frontpanel version, License information Download Support Archive

HOME

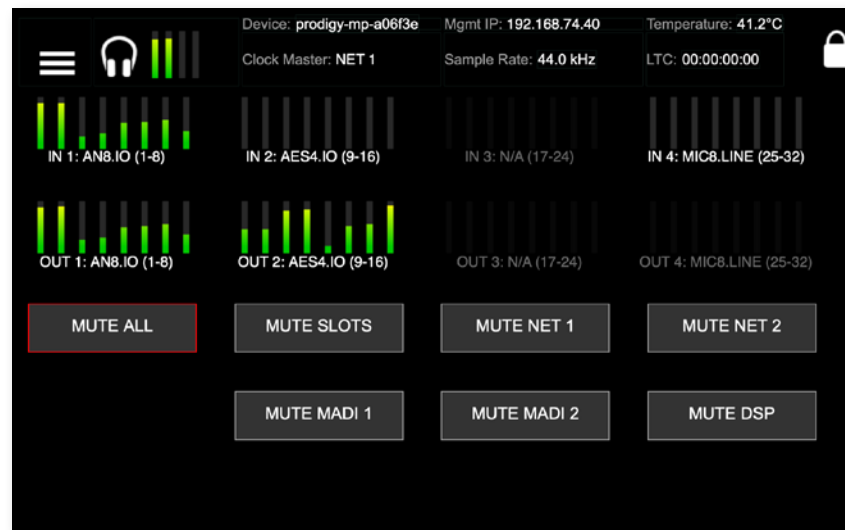

The HOME screen displays:

- Level metering (input / output) of all eight converter slots
- Level metering of headphones outputs
- Device name (Device)
- IP address for device management (Mgmt IP)
- Temperature
- Clock Master
- Sample Rate
- LTC Reader display (LTC)
- MUTE buttons to mute all or individual outputs or signal paths
- Lock icon to lock / unlock access

Tap / click	to open / <function>
Burger icon	Main Menu
Clock Master	Clock Settings
Mgmt IP	Network Settings
Level Meter	zoomed display of eight channels
Encoder (CONTROL)	Phones volume control or to toggle the selection between PHONES 1 and PHONES 2. Rotate to modify values. Automatic timeout of the control display is about 5 seconds. *

* When controlling via browser the phones volume control is accessed by pressing the <ENTER> key on the keyboard. Level is adjusted via arrow keys (left and right).

Tap / click	to open / <function>
Lock icon	Lock or unlock the device control with a pin code. *
MUTE ALL	Mute / Un-mute all physical outputs and signal paths
MUTE SLOTS	Mute / Un-mute all outputs of converter slots (Slots C1 to C4)
MUTE NET 1	Mute / Un-Mute output of network 1 (Slot A1)
MUTE NET 2	Mute / Un-Mute output of network 2 (Slot A2)
MUTE MADI 1	Mute / Un-Mute output of MADI 1 (Slot B1)
MUTE MADI 2	Mute / Un-Mute output of MADI 2 (Slot B2)
MUTE DSP	Mute / Un-Mute of DSP blocks (not bypassing) **

* A four-digit pin code needs to be defined when locking for the first time. To unlock device the pin code is required. The pin code can be reset in the PRODIGY.MP plugin of globcon (Settings / Front Panel) when the device is locked or in the device settings (see "SETTINGS" on page 80) when the device is unlocked.

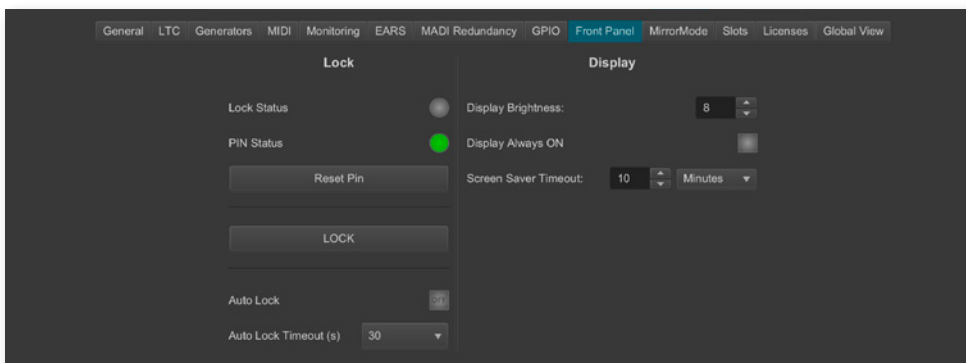

** MUTE DSP will interrupt the signal chain at the DSP block section, but not mute a physical output.

CLOCK

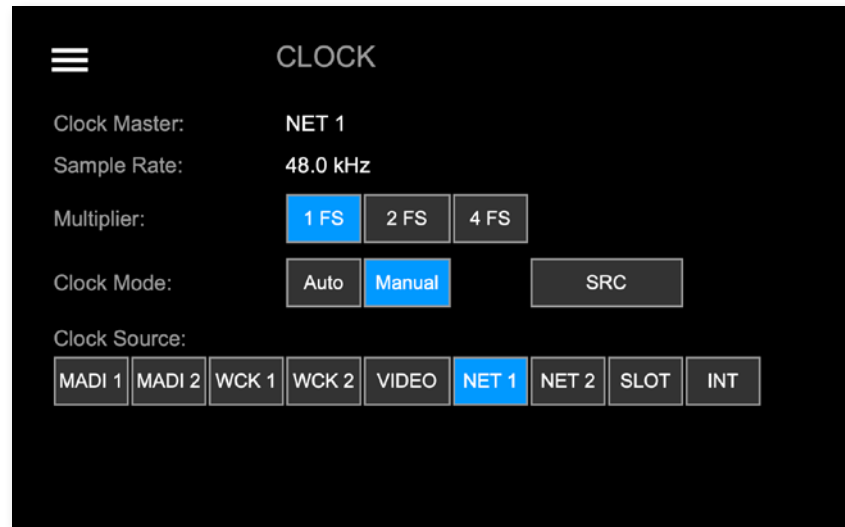

The CLOCK Settings displays:

- Clock Master: Current master for system clock
- Sample Rate: measured sample rate
- Icons to adjust the scaling factor of the base rate
- Icons to select Clock Mode (Auto or Manual) and to open SRC settings
- Icons to select the clock master

Tap / click	to open / set*
Burger icon	Main Menu
1 FS	Scaling factor to 1 FS (usually 44.1 or 48 kHz)
2 FS	Scaling factor to 2 FS (usually 88.2 or 96 kHz)
4 FS	Scaling factor to 4 FS (usually 176.4 or 192 kHz)
Auto	Clock source is set automatically following the priority settings in globcon.**
Manual	Clock source is set manually according the selection below (Clock Source:).
SRC	Submenu to activate / deactivate SRC - see p 72
MADI 1	Slot B1 input as Clock Master
MADI 2	Slot B2 input as Clock Master
WCK 1	Word Clock input 1 as Clock Master
WCK 2	Word Clock input 2 as Clock Master

VIDEO	Video signal @ Word Clock input 2 as Clock Master***
NET 1	Slot A1 as Clock Master
NET 2	Slot A2 as Clock Master
SLOT	AES3 input as Clock Master ****
INT	Internal Generator as Clock Master
44.1	Base Rate to 44.1 kHz [INT]
48	Base Rate to 48 kHz [INT]

- * the value set is marked by the particular icon with a blue background
- ** The priority setting allows to define several fallbacks if a clock source fails. It also offers reverting to a higher prioritized clock source (Auto Enable / Enable) when its signal returns.

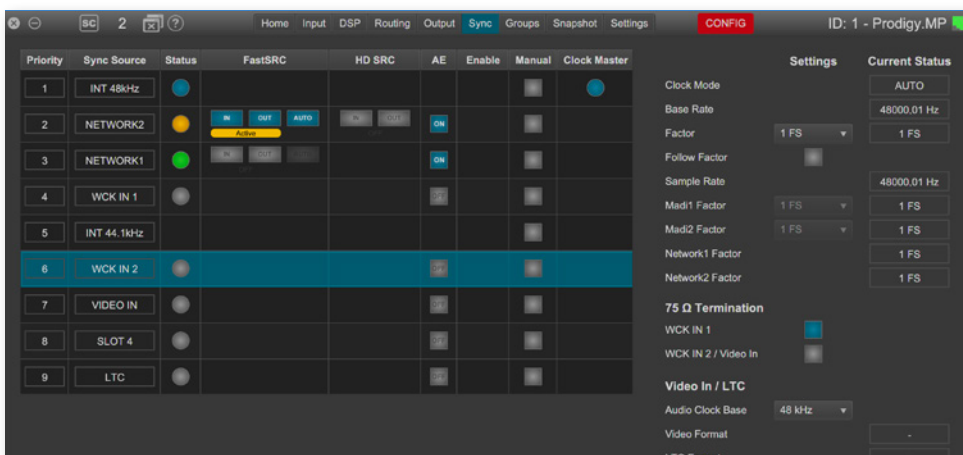

- *** Word Clock input 2 also accepts analog video signal (black burst, tri-level). Selecting 'Video In' as clock source configures the 'WCK2 In' to 'Video In' in the background.
- **** requires AES4.IO or AES4.SRC.IO installed - the first AES3 port receiving a valid signal will be used as clock source.

FastSRC™ / HD SRC

The FastSRC™ is a low latency sample rate converter that is available for the A Slots (audio network, multi-port MADI, USB) and B Slots (single-port MADI). HD SRC is a state-of-the-art sample rate converter which is offered with all SRC modules (XX.SRC.IO) - see page 74.

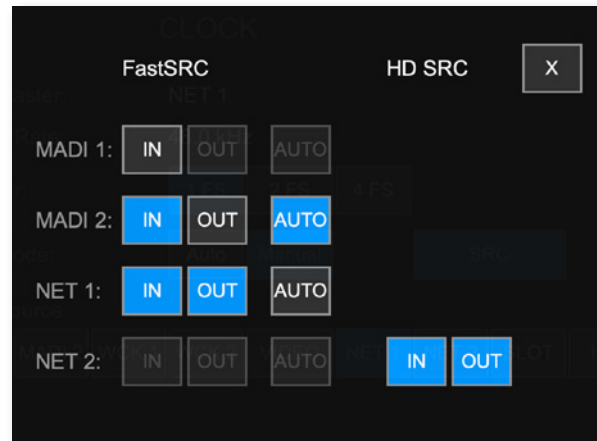

The SRC screen displays:

- buttons to activate or deactivate FastSRC™ or HD SRC at individual I/Os

Tap / click	to open / set*
X	Clock page
MADI 1/2 - IN	Activate / Deactivate FastSRC™ at MADI 1/2 input
MADI 1/2 - OUT	Activate / Deactivate FastSRC™ at MADI 1/2 output
MADI 1/2 - AUTO	Activate / Deactivate Automatic Bypass for FastSRC™ at MADI 1/2
NET 1/2 - IN or OUT	Activate / Deactivate FastSRC™ at NET 1/2 input & output*
NET 1/2 - AUTO	Activate / Deactivate Automatic Bypass for FastSRC™ at NET 1/2 input & output
NET 1/2 IN or OUT (HD SRC)	Activate / Deactivate HD SRC at NET 1/2 input & output**

* For the audio network I/Os the FastSRC™ may be activated for input and output together only. For the multi-port MADI modules with an active SRC at the input, the SRC at the output may be switched on or off.

** With HD SRC active, the FastSRC™ and the automatic bypass become inactive.

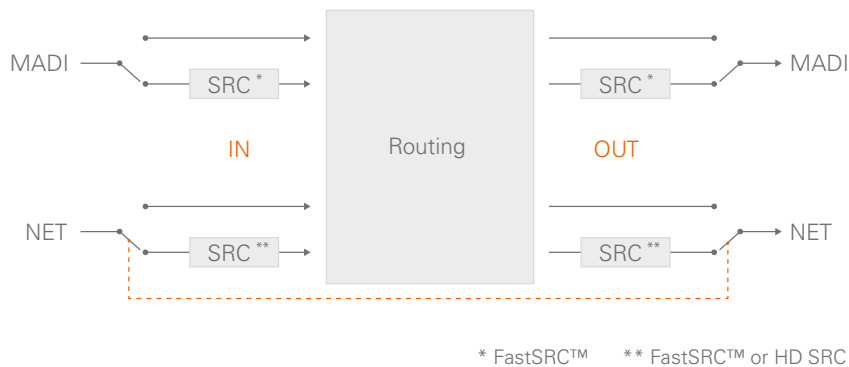

NOTE



If an input is used as clock source for the device it is neither necessary nor recommended to activate the FastSRC™ or HD SRC.

Automatic Bypass for FastSRC™

With ‚AUTO‘ activated sample rate conversion is applied depending from the sync state of the input signal:

- in sync with the system clock
- not in sync with the system clock

AUTO	FastSRC™	Signal in Sync	Sample Rate Conversion	Latency added
n.a.	OFF	yes / no	inactive	no
OFF	ON	yes / no	active	< 0.15 ms
ON	ON	yes	inactive	< 0.15 ms
		no	active	
		yes again*	automatic bypass after 60 seconds	

* 60 seconds after the signal is in sync with the system clock again, sample rate conversion is bypassed.

The automatic switch-over will not change the latency (less than 0.15 ms) of the signal path.

About FastSRC™

DirectOut's FastSRC™ is a low latency sample rate converter for when two digital interfaces of a device must work in different clock domains.

FastSRC™ combines good sound quality with very low latency of less than 0.15 msec and is invaluable in live sound applications and a "life-saver" in critical situations.

High-end sample rate conversion requires noticeable processing power, so for the very best audio quality we recommend DirectOut's dedicated SRC products such as the SRC version of the audio network modules or the multi-port MADI modules - see About HD-SRC.

About HD SRC

DirectOut's HD SRC is a state-of-the-art sample rate converter with a latency of about 1 msec.

HD SRC is available for the audio network modules:

- RAV.SRC.IO
- DANTE.SRC.IO
- SG.SRC.IO
- MILAN.SRC.IO

or the multi-port MADI modules:

- MADI2.SRC.IO
- MADI2.BNC.SRC.IO
- MADI4.SRC.IO

This page is left blank intentionally.

SNAPSHOTS

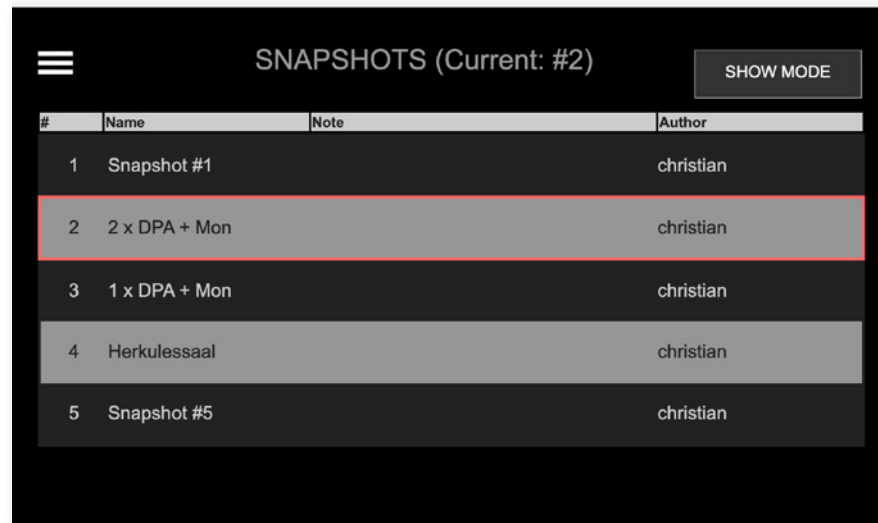

The SNAPSHOT screen displays:

- list of snapshots that are stored in the device (up to 99 snapshots)
- button to toggle between 'Show Mode' and 'Config Mode'.

Tap / click	to
snapshot entry	recall snapshot - after confirming a prompt
Show / Config Mode	toggle the operating mode between 'Show' to 'Config'

Each snapshot which is created in globcon will be stored into the device.

As a snapshot can be stored within a globcon project, it is possible to reconfigure a device including snapshots via 'Push' function from globcon.

The selected snapshot is surrounded by a red frame.

After recalling a snapshot in 'Config Mode' all outputs will be muted (MUTE ALL).



NOTE

Show Mode - Only compliant snapshots are listed and available for recall.

Snapshots - Compliance

compliant	Snapshot Data Set matches the Configuration Settings of the device.
non-compliant	Snapshot Data Set does not match the Configuration Settings of the device. Conform procedure required for recall in Show Mode or recall with full Scope Set in Configuration Mode, thus changing the Configuration Settings.

See document '[Info PRODIGY.MP Supplemental](#)' for more information about the Operating Modes and Snapshots.

TIP

Conform snapshots after changing configuration settings, such as Flex Channel style, MatMix bus configuration, Plugin insert...

NETWORK

The NETWORK Settings displays:

- IP Address for the management ports (MGMT)
- Subnet Mask for the management ports (MGMT)
- Gateway for the management ports (MGMT)

Tap / click	Function
Burger icon	Link to Main Menu
DHCP	Enable / Disable DHCP * grey = DHCP OFF, manual input required blue = DHCP ON, network settings are assigned automatically
SAVE	Stores changes to the device
Input field	Input of values **

* DHCP (Dynamic Host Control Protocol) = device's IP Address is assigned automatically by a DHCP server in the network

** the values are entered via the Encoder if DHCP is OFF

Enter values:

- select field
- turn the Encoder to adjust the value or use the arrow keys (left and right)
- de-select field
- tap SAVE to store the changes

NOTE



System Build 20 fro PRODIGY.MP introduced Link Local Address support if DHCP is not answering (zeroConf).

SETTINGS

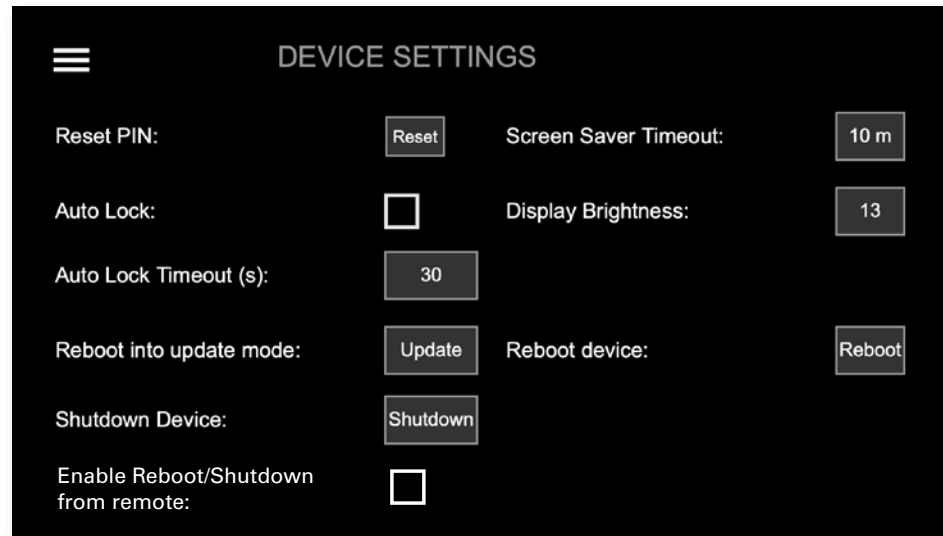

The DEVICE Settings allows to:

- Reset the four-digit PIN code used for device lock
- Enable / disable Auto Lock
- Define the timeout for Auto Lock function
- Reboot the device into update mode for system updates or license installation
- Shut down the device to ensure proper file operation before switching the device off.
- Adjust timeout of screen saver
- Adjust brightness of front panel display
- Manage security setting for shutdown or reboot from remote - see p 82.
- Reboot the device to restart all services.

Tap / click	Function
Reset	Resets the PIN code.
Auto Lock	Enable <input checked="" type="checkbox"/> Disable <input type="checkbox"/>
Auto Lock Timeout (s)	Timeout in seconds to lock the device automatically when Auto Lock is enabled. Values: 10 to 180 seconds
Reboot	Reboots the device in update mode
Shutdown	Terminates all services, fans may run at full speed, leds and display are switched off, LED MGMT = blue
Enable Reboot/ Shutdown from remote*	Enable <input checked="" type="checkbox"/> Disable <input type="checkbox"/>
Screen Saver Timeout	Period of inactivity after which the display is switched off Values: 1 min to 96 h, always ON (globcon)
Display Brightness	Level of brightness Values: 1 to 14
Reboot device	Reboot the device to restart all services.

* at front panel only

Enter values:

- select field
- turn the Encoder to adjust the value or use the arrow keys (left and right)
- de-select field



WARNING

Disabling the screen saver or high levels of brightness will impact the lifecycle of the display significantly.

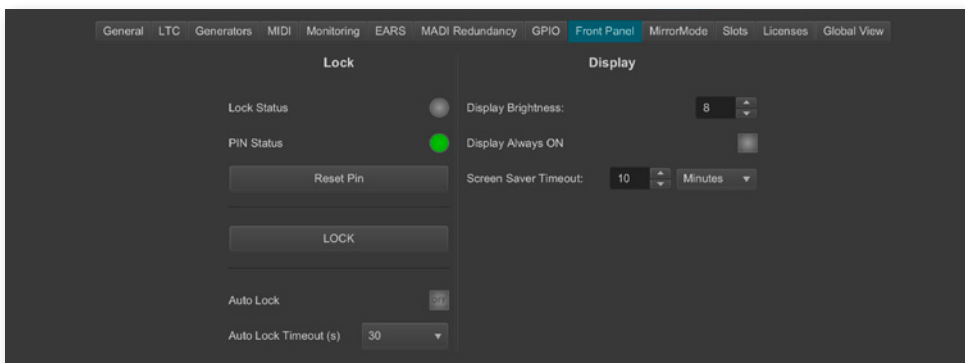

Shutdown / Reboot into update mode

Both commands can also be used remotely via globcon or the web UI, once the feature has been activated on the front panel:

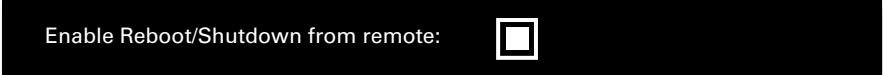

This setting is persistent and will be restored after a power-cycle or reboot.



WARNING

Enabling 'Reboot/Shutdown from remote' can be a security risk, if the management network can be accessed freely. It is disabled by default.

To use the new commands in globcon:

- activate the Configuration Mode
- navigate to Settings - General

You will be prompted to type 'shutdown' or 'update' or 'reboot' to use either command.

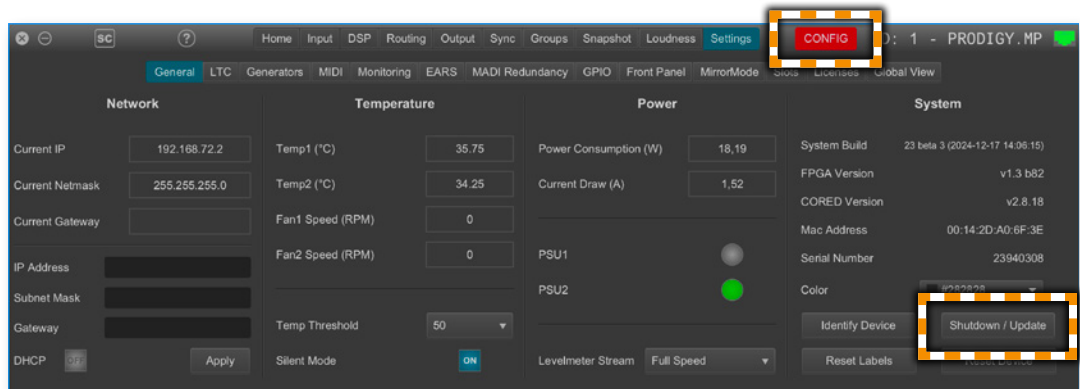

This page is left blank intentionally.

INFO



DEVICE INFO displays:

- Device Name
- Serial No
- System Build: Version and date
- FPGA Version: audio processing
- cored Version: device management
- Frontpanel Version: local operation
- Support: Support Archive
- License information about installed licenses and their service state
- License information for open source software that is used by this device

Tap / click	to open / generate
Burger icon	Main Menu
Download Support Archive *	a support archive (*.pdgs) Example: prodigy_support_2019-11-19_12-34-33.pdgs
PRODIGY License Info	subpage with information about installed licenses and service state
Software License Info	subpage with license information about open source software

* the support archive is generated and downloaded into the downloads folder of your browser. You may send it to support@directout.eu for troubleshooting.

INFO

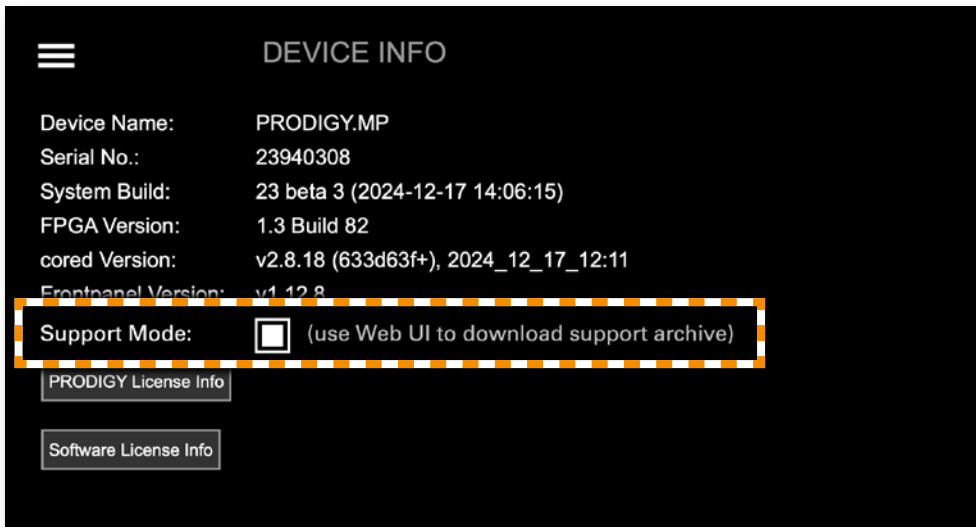

Support Mode

Support mode active enables a remote connection via SSH.

It allows access of the device via remote and shall be activated only upon request by support authorized from DirectOut.

To prevent unauthorized access the support mode:

- can only be activated via the front panel
- becomes inactive automatically at the next power-cycle

PRODIGY License Information

For enhanced scalability the PRODIGY series can be ordered with different system licenses - Essential, Advanced, Unlimited. Additional single licenses can be acquired on demand.

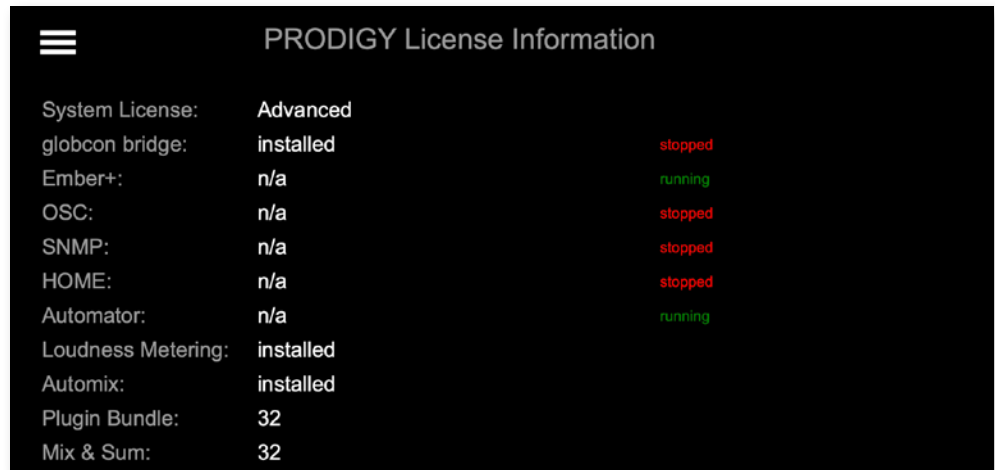

The PRODIGY License Information displays:

- system license (Essential, Advanced or Unlimited)
- services - license availability and its operating status
- single licenses - availability

For testing purposes a demo session can be initiated via globcon after startup to activate the feature for 30 minutes.

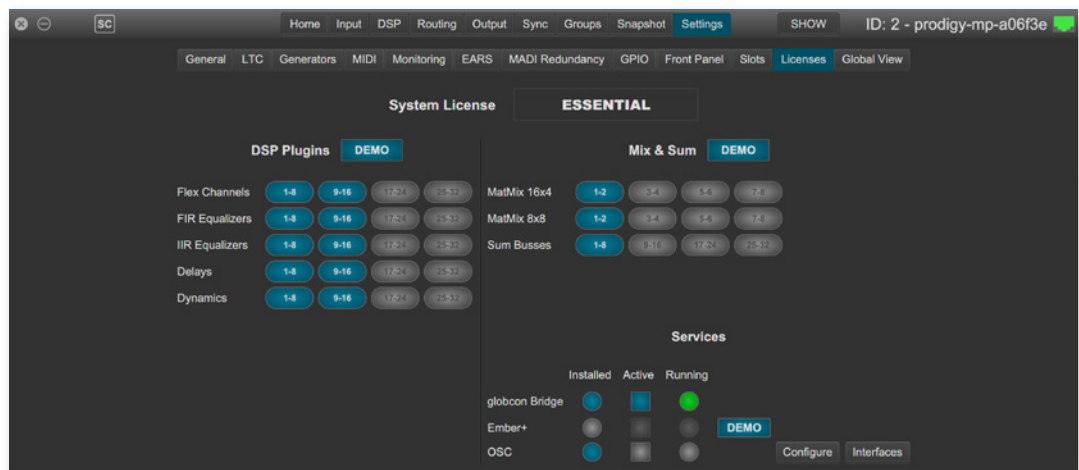

To acquire a license please contact your local DirectOut representative.



NOTE

Licenses are installed via license files which are coupled with the device's serial number. To install a license file the device must be operated in update mode - see "Appendix D- System Update & License Installation" on page 103.

LEVEL METER - INPUT (MIC8.LINE.IO)

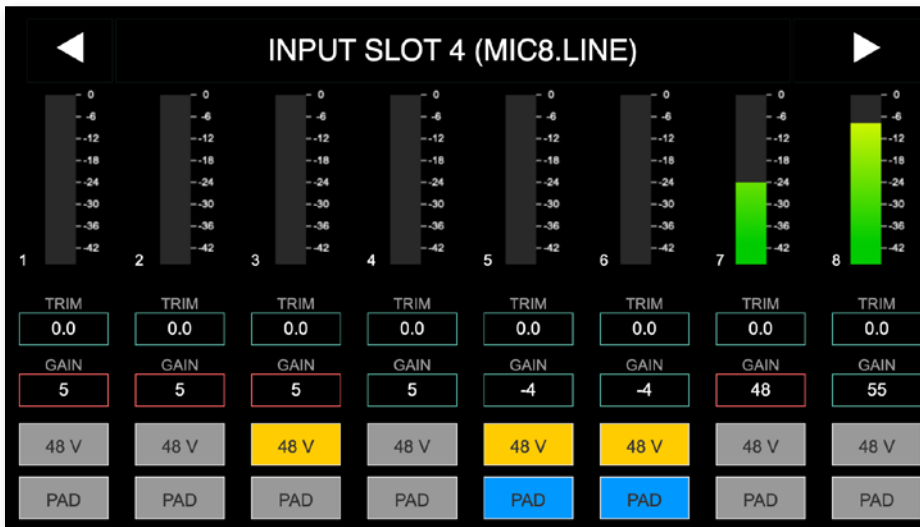

The LEVEL METER - INPUT (MIC8.LINE.IO) displays:

- Level meters for a single converter slot- 8 channels
- Slot number and module type inserted
- control for input level, mute and phantom power (depending on the module)

Tap / click	to
Arrow left	navigate to previous module*
Arrow right	navigate to next module*
INPUT SLOT	return to HOME screen
Trim** / Gain	select field(s) for modifying values of trim and gain. <input type="checkbox"/> selected <input type="checkbox"/> unselected
48 V	phantom power (48 V) <input checked="" type="checkbox"/> 48 V enabled <input type="checkbox"/> 48 V disabled
PAD	enable / disable PAD (-9 dB MIC8 / - 30 dB MIC8.HD) <input checked="" type="checkbox"/> PAD enabled <input type="checkbox"/> PAD disabled

* the arrows are used for circular navigation through slots 1 to 4 input, followed by slot 1 to 4 output.

** displayed with a yellow background, when the value is not zero

To adjust the level:

- select field(s)
- turn the Encoder or use the arrow keys (left and right)
- un-select field(s) when finished
- to zero the value, press the Encoder

Values:

Gain: module dependent

Trim: from - 24 dB to + 24 dB

LEVEL METER - INPUT (AN8.IO)

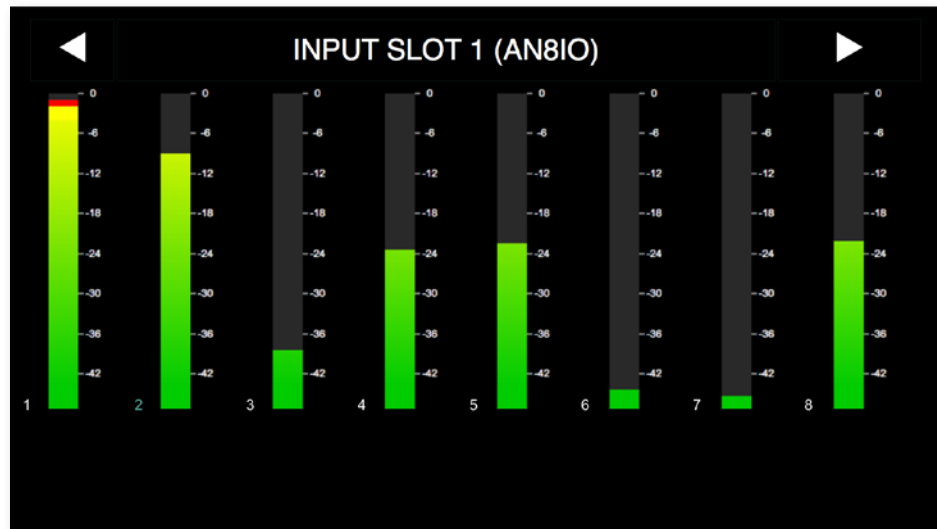

The LEVEL METER - INPUT displays:

- Level meters for a single converter slot- 8 channels
- Slot number and module type inserted

Tap / click	to
Arrow left	navigate to previous module*
Arrow right	navigate to next module*
INPUT SLOT	return to HOME screen

* the arrows are used for circular navigation through slots 1 to 8 input, followed by slot 1 to 8 output.

LEVEL METER - OUTPUT

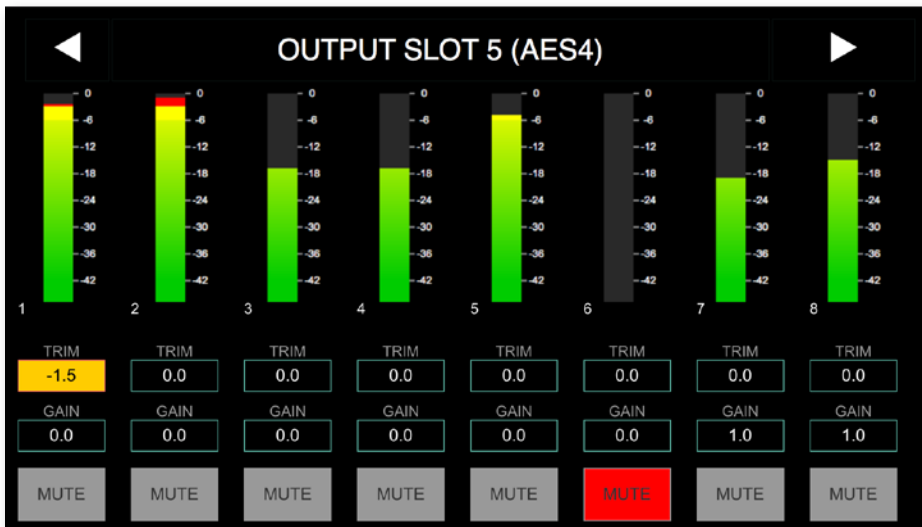

The LEVEL METER - OUTPUT displays:

- Level meters for a single converter slot - 8 channels
- Slot number and module type inserted
- control for level, mute and phantom power (depending on the module)

Tap / click	to
Arrow left	navigate to previous module*
Arrow right	navigate to next module*
OUTPUT SLOT	return to HOME screen
Trim** / Gain	select field(s) for modifying values of trim and gain. <input type="checkbox"/> selected <input type="checkbox"/> unselected
MUTE	enable / disable mute <input checked="" type="checkbox"/> MUTE enabled <input type="checkbox"/> MUTE disabled

* the arrows are used for circular navigation through slots 1 to 4 input, followed by slot 1 to 4 output.

** displayed with a yellow background, when the value is not zero

To adjust the level:

- select field(s)
- turn the Encoder or use the arrow keys (left and right)
- un-select field when finished
- to zero the value, press the Encoder

Values:

Gain: module dependent

Trim: from - 24 dB to + 24 dB

CHAPTER 6: Troubleshooting and Maintenance

Troubleshooting

To identify a possible defect with the device please consult the following table. If the fault cannot be resolved using these instructions, please contact your local DirectOut representative or visit support.directout.eu.

Issue	Possible reason	Solution
Device doesn't work.	Power supply is broken.	Check that the power supply switch is on, that the device is connected to the power supply and that the socket is working. Defective fuses must be exchanged by qualified service personal only.
Optical port does not work.	Optic is dirty.	Use an air supply to carefully remove any dust. Never use objects for cleaning.
No signal at the output port.	Connections (input / output) are mixed up.	Check the connections and change the cables if necessary. Check the routing matrix.
No signal at the output port.	Signal cable defective.	Exchange the signal cable.
MADI signal at the input is not stable.	Signal source is defective or bad signal condition (Jitter > 1 ns)- e.g. due to exceeded length or bad screening attenuation of signal cable.	Change the source or use appropriate cables.
Clicks in the audiosignal.	Input source is not in sync with clock master of the box.	Check the status of input LED and check clock setting of the connected device.

Maintenance

To clean the device, use a soft, dry cloth. To protect the surface, avoid using cleaning agents.

NOTE!



The device should be disconnected from the power supply during the cleaning process.

CHAPTER 7: Technical Data

Dimensions (sketch on page 102)

- Width 19" (483 mm)
- Height 2 RU (89 mm)
- Depth 10" (254 mm)
- Weight about 10 kg

Power Consumption

- 20 W to 110 W, module dependent

Power Supply

- 2 x 84 V- 264 V AC / 47 Hz- 63 Hz / Safety class 1

Fuses

- Fuse 250 V- 4 A (slow-blow) – 2 fuses per power supply

Environmental Conditions

- Operating temperature +5°C up to +45°C
- Relative humidity: 10%- 80%, non condensing

Display

- 5.0" Backlight LED LCD, IPS Transmissive
- Resolution: 480 x 854 px

Control

- 1 x Encoder knob with push functionality
- 2 x Push-Buttons

Network

- 2 x RJ45 Gigabit Ethernet, 1 x SFP cage
- for managing the device (remote control)

Remote Control

- globcon software control
- integrated web server with UI (HTML, JavaScript)
- Ember+ (license) - MGMT <IP Address>:9000
- OSC (license)
- SNMP (license)

Word Clock

- 4 x BNC socket (input / output), WCK 2 switchable to Video Sync
- Video sync: analog, black burst or tri-level
- Impedance: 75 Ω (termination switchable)
- AES11 (DARS also supported)

Sample Rate

- 30 - 50 kHz @ 1 FS
- 60 - 100 kHz @ 2 FS
- 120- 200 kHz @ 4 FS

Phones Out 1

- 1 x 6.3 mm TRS jack, mono / stereo
- Output level: max. +18 dBu
- SNR: -115 dB RMS (20 Hz- 20 kHz) / -118 dB(A)
- THD+N @ 0 dBFS: -105 dB @ 600 Ω

Phones Out 2

- 1 x 3.5 mm TRS jack, mono / stereo
- Output level: max. +12 dBu
- SNR: -115 dB RMS (20 Hz- 20 kHz) / -118 dB(A)
- THD+N @ 0 dBFS: -105 dB @ 600 Ω

USB

- 2 x USB socket (Type A)
- for legacy control via globcon bridge

GPIO

- 2 x GPI (MOSFET switch),
- 2 x GPO (MOSFET switch)

MADI Port SC optical

- 1 x SC socket FDDI (input / output)
- ISO/IEC 9314-3
- Wave length 1310 nm
- Multi-Mode 62.5/125 or 50/125

MADI Port BNC coaxial

- 2 x BNC socket (input / output)
- Impedance: 75 Ω
- 0.3 V up to 0.6 V (peak to peak)

MADI Port SFP

- 1 x SFP (empty cage without module)

MADI Format (I/O)

- 48k Frame, 96k Frame, S/MUX or Native
- High Speed or Legacy
- 56 channel, 57 channel, 64 channel

Analog I/O level line

- +15 / +18 / +24 dBu changeable via jumper on module

MIC8.HD.I

- Input sensitivity:-55 dBu to +30 dBu
- EIN:-128 dBu
- THD @-1 dBFS:-113 dB
- Frequency response:-0.15 dB (10 Hz) /-0.15 dB (20 kHz)
- 30 dB PAD (switchable)
- +48 V phantom power (switchable)

MIC8.LINE.IO

- Input sensitivity:-55 dBu to +24 dBu
- EIN:-118 dBu
- SNR:-115 dBFS (20 Hz- 20 kHz) /-118 dB(A) @ 0dB Gain
- THD @-1 dBFS:-113 dB
- Frequency response:-0.5 dB (10 Hz to FS/2)
- 9 dB PAD (switchable)
- +48 V phantom power (switchable)

A/D

- SNR:-117.6 dB RMS (20 Hz- 20 kHz) /-119.9 dB(A)
- THD @-1 dBFS: <-119 dB
- Frequency response: <-0,15 dB (10 Hz) /-0,15 dB (20 kHz)

D/A

- SNR:-116.8 dB RMS (20 Hz- 20 kHz) /-119.5 dB(A)
- THD @-1 dBFS:-109 dB
- Frequency response:-0,5 dB (10 Hz) /-0,15 dB (20 kHz)

AN8.IO

- 8 ch line input / output, 2 x DSUB-25, balanced

AN8.O

- 8 ch line output, 1 x DSUB-25, balanced

AN8.I

- 8 ch line input, 1 x DSUB-25, balanced

MIC8.HD.I

- 8 ch mic high definition input, 1 x DSUB-25, balanced

MIC8.HD.IO

- 8 ch mic high definition input / line output, 2 x DSUB-25, balanced

MIC8.LINE.IO

- 8 ch mic/line input / line output, 2 x DSUB-25, balanced

MIC8.LINE.I

- 8 ch mic/line input, 1 x DSUB-25, balanced

AES4.IO

- 4 port AES3 input / output, 1 x DSUB-25 (8 audio channels)

AES4.SRC.IO

- 4 port AES3 input with SRC / output, 1 x DSUB-25 (8 audio channels)

BNC.IO

- MADI, 64 ch @ 1 FS, 32 ch @ 2 FS, 16 ch @ 4 FS
- 1 x coaxial BNC input, 1 x coaxial BNC output, 75 Ω

SC.IO

- MADI, 64 ch @ 1 FS, 32 ch @ 2 FS, 16 ch @ 4 FS
- 1 x SC-Socket duplex multi-mode (single mode on request)

SFP.IO

- MADI, 64 ch @ 1 FS, 32 ch @ 2 FS, 16 ch @ 4 FS
- 1 x SFP cage (matching SFP transceiver available from DirectOut)

MADI2.SRC.IO

- MADI, 128 ch @ 1 FS, 64 ch @ 2 FS, 32 ch @ 4 FS
- 2 x SFP cage (matching SFP transceiver available from DirectOut)

MADI2.BNC.SRC.IO

- MADI, 128 ch @ 1 FS, 64 ch @ 2 FS, 32 ch @ 4 FS
- 2 x coaxial BNC input, 2 x coaxial BNC output, 75 Ω

RAV.IO / RAV.SRC.IO

- Network Audio RAVENNA / AES67, 128 ch @ 1 FS, 64 ch @ 2 FS, 32ch @ 4 FS
- 2 x RJ45, 1x SFP

DANTE.IO / DANTE.SRC.IO

- Network Audio Dante, 64 ch @ 1 FS, 32 ch @ 2 FS, 16ch @ 4 FS
- 2 x RJ45, 1x SFP

SG.IO / SG.SRC.IO

- Network Audio Waves SoundGrid, 128 ch @ 1 FS, 64 ch @ 2 FS
- 2 x RJ45, 1x SFP

MILAN.IO / MILAN.SRC.IO

- Network Audio AVB / MILAN, 128 ch @ 1 FS, 64 ch @ 2 FS, 32 ch @ 4 FS
- 2 x RJ45, 1x SFP

USB.IO

- USB 3.0 Audio, 128 ch @ 1 FS, 64 ch @ 2 FS, 32 ch @ 4 FS
- USB 2.0 Audio, 64 ch
- USB C with USB 2/3 support and top screw locking
- Driver Windows: ASIO, WDM
- Driver macOS: Kernel Extension, Driver Kit Core Audio
- USB class-compliant mode with full USB 3.0 support and 128 channels I/O
- TotalMix FX

Index

A

Accessory	
BREAKOUT.....	17
Patch Chords	18
SFP Transceiver- MADI.....	19
SFP Transceiver- Network.....	20
AES59.....	53, 54, 55, 56, 58
Analog Split.....	52
ANDIAMO	62
Automatic Bypass FastSRC™.....	73

B

BREAKOUT.....	17
---------------	----

C

Clocking.....	61
Conditions of Warranty see Warranty	
Conformity & Certificates	
CE.....	15
RoHS	15
WEEE	15
Contact	15
Contents.....	16
Conventions.....	7

D

Defective Parts/Modules	12
Dimensions.....	92, 102
DSUB-9.....	101
DSUB-25.....	100

E

Environmental Conditions.....	22, 92
-------------------------------	--------

F

FastSRC™.....	72
Feature Summary	9
First Aid	13
Fuses	92

G

globcon	16
---------------	----

H

HD SRC.....	72
-------------	----

I

Intended Operation.....	14
IP address	
default.....	24

L

License	
information	86
installation	103

M

MGMT	29
------------	----

N

Network Standards	9
-------------------------	---

P

Patch Chords	18
--------------------	----

R

Reboot	
device	80
into update mode	81
Remote Control	16
Reset see Factory Reset	

S

Scaling Factor	26
SFP Transceiver.....	19
Shutdown	81
Single-/Multi-mode	44
Support.....	90
Support Mode.....	85
System Update	103

T

Technical Data.....	92
Troubleshooting	90

U

Update Mode.....	103
Updates	14
USB Audio (USB.IO)	42, 62

V

Video sync	60
------------------	----

W

Warranty	14
WEEE See Conformity & Certificates: WEEE	
Word clock.....	60

Appendix A - DSUB-25 Pin assignment

The pinout of the DSUB-25 connectors for the transmission of analog and AES3 audio signals follows the AES59 specification.

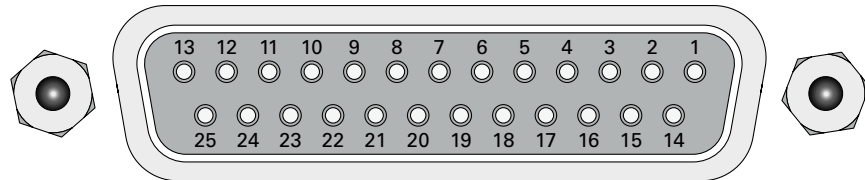

jack- female

PIN	Signal analog	Signal digital
1	CH 8 +	CH 4 OUT +
2	GND	GND
3	CH 7 -	CH 3 OUT -
4	CH 6 +	CH 2 OUT +
5	GND	GND
6	CH 5 -	CH 1 OUT -
7	CH 4 +	CH 4 IN +
8	GND	GND
9	CH 3 -	CH 3 IN -
10	CH 2 +	CH 2 IN +
11	GND	GND
12	CH 1 -	CH 1 IN -
13		
14	CH 8 -	CH 4 OUT -
15	CH 7 +	CH 3 OUT +
16	GND	GND
17	CH 6 -	CH 2 OUT -
18	CH 5 +	CH 1 OUT +
19	GND	GND
20	CH 4 -	CH 4 IN -
21	CH 3 +	CH 3 IN +
22	GND	GND
23	CH 2 -	CH 2 IN -
24	CH 1 +	CH 1 IN +
25	GND	GND

Appendix B - DSUB-9 Pin assignment

The pinout of the DSUB-9 connector for the GPI (General Purpose Input) and GPO (General Purpose Output) or the word clock out (PRODIGY.MX) connection.

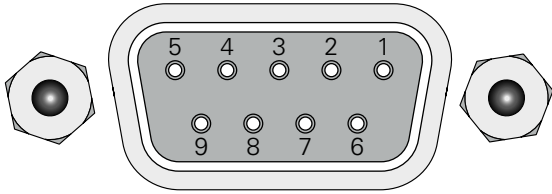

jack- female

PIN	Signal GPIO	Signal WCK OUT
1	GND	GND
2	GND	WCK 2
3	GND	GND
4	+ 12 V	WCK 5
5	+ 12 V	GND
6	GPI 2	WCK 1
7	GPI 1	WCK 3
8	GPO 2	WCK 4
9	GPO 1	WCK 6

GPI - 3.3 V CMOS compatible, low active

Can be triggered by connecting the input pin with ground (GND) or by a voltage source between input pin and ground.

Input voltage: max 30 V DC

GPO - Open drain MOSFET switch - max. 30 V, max. 200 mA.

Power supply: + 12 V, max. 200 mA (in total)

The pinout (3, 4, 5, 8, 9) complies with the GPO of PRODUCER.COM

WCK OUT - system clock output

Slots:

- Slot A - Audio Network / Multi-port MADI / USB Modules
- Slot B - Single-port MADI Modules
- Slot C - Converter Modules

Appendix C - Dimensions

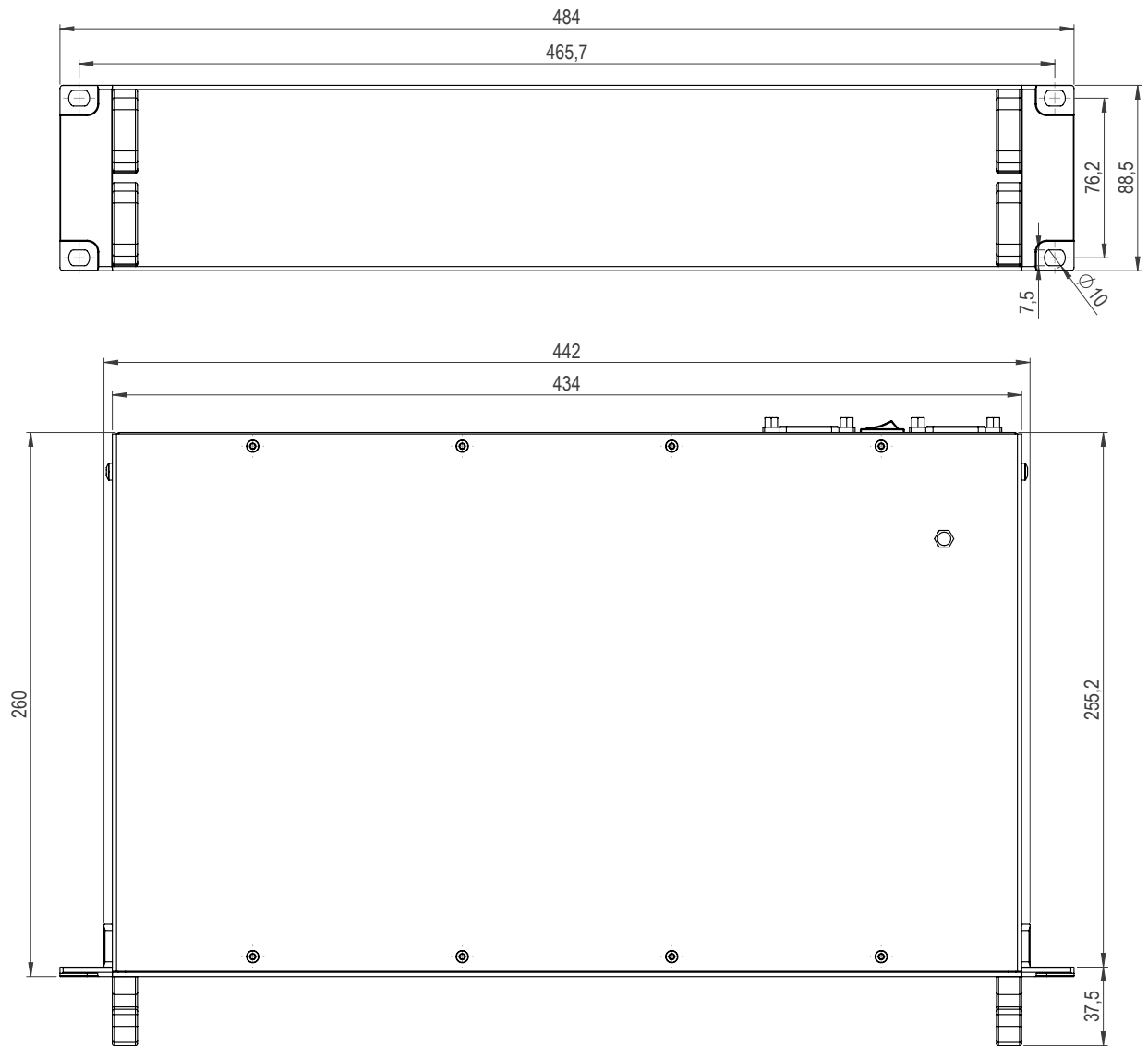

Appendix D - System Update & License Installation

To update the system of PRODIGY or to install a license the device must be rebooted in Update Mode.

WARNING!



It is strongly recommended to backup the device configuration (Save Preset) before running any update.

1. Download Image Archive from the product page at www.directout.eu
2. Unzip the Image file => prodigy_<xx>_system_update_<build>_<date>.pdgy
3. Start the device in Update Mode:
 - Method A
 - Press and hold the button HOME on the front panel and switch the device on.
 - Once the DirectOut logo disappears you may release the button.
 - Method B (introduced with system build 26 [MC] or build 12 [MP])
 - front panel: open SETTINGS and click Reboot

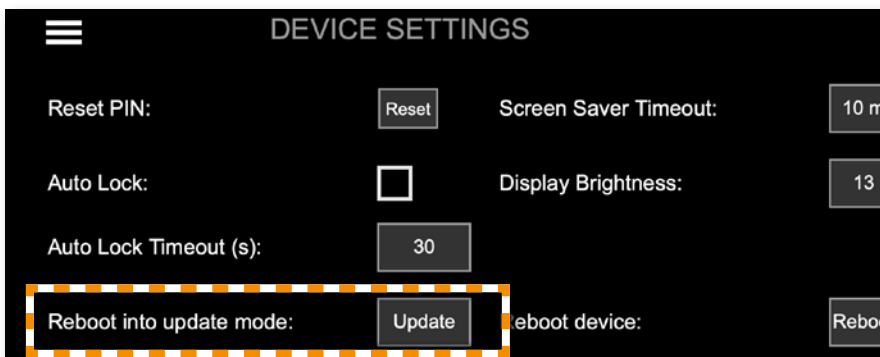

This command can also be used remotely via globcon or the web UI, once the feature has been activated on the front panel:

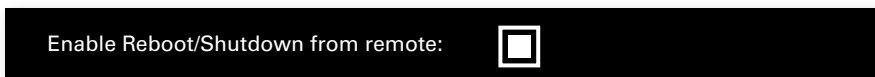

This setting is persistent and will be restored after a power-cycle or reboot.

WARNING



Enabling 'Reboot/Shutdown from remote' can be a security risk, if the management network can be accessed freely. It is disabled by default.

4. Enter the device's IP Address in your browser (Mozilla Firefox or Google Chrome). It is displayed in the front panel display. The IP address may vary in update mode when the network settings are set to DHCP.



TIP

To keep the identical IP address in both operating modes, configure the network settings manually before rebooting into update mode.

5. Click Start Update

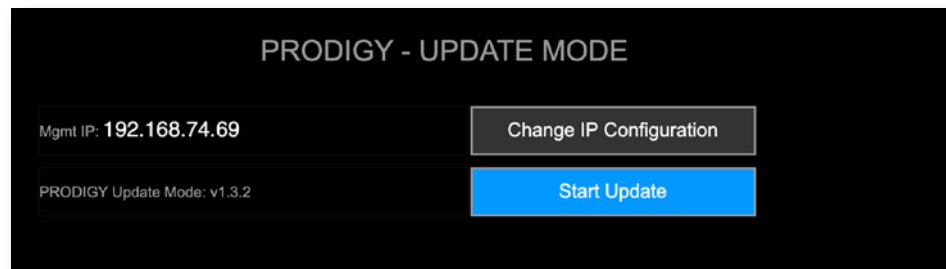

6. Choose the downloaded file for upload (*.pdgy)

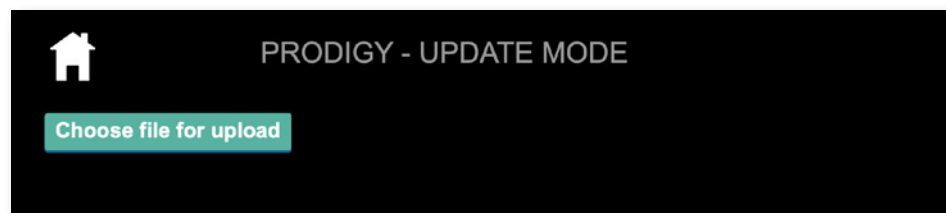

The update process will start after confirming your selection.

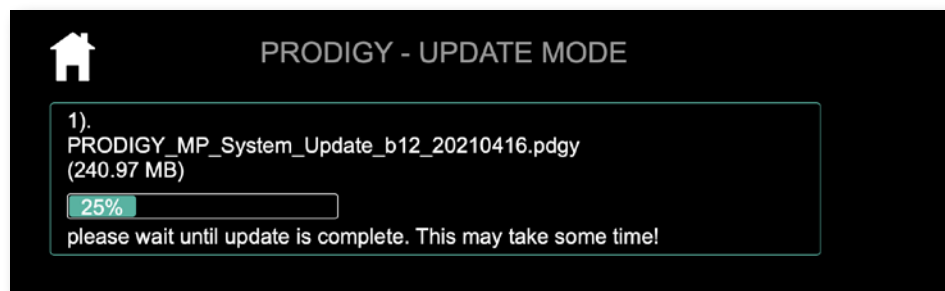

The entire update may take a couple of minutes. Once the update is stored into the device a reboot message will appear. The update progress messages are displayed below the upload box (green rectangle).

7. Once the reboot message appears you can power cycle the unit.

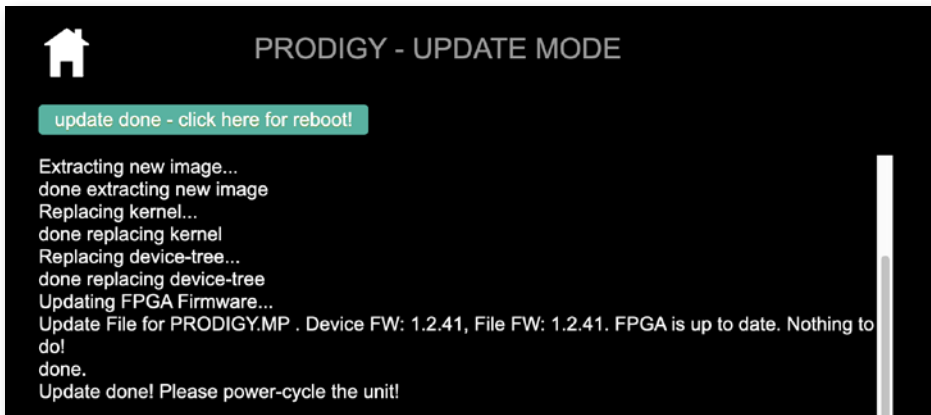

TIP



Installation of multiple licenses (not a system update!):

To install multiple licenses without rebooting the device in between, click on the HOME icon after the installation of a license has been completed successfully.

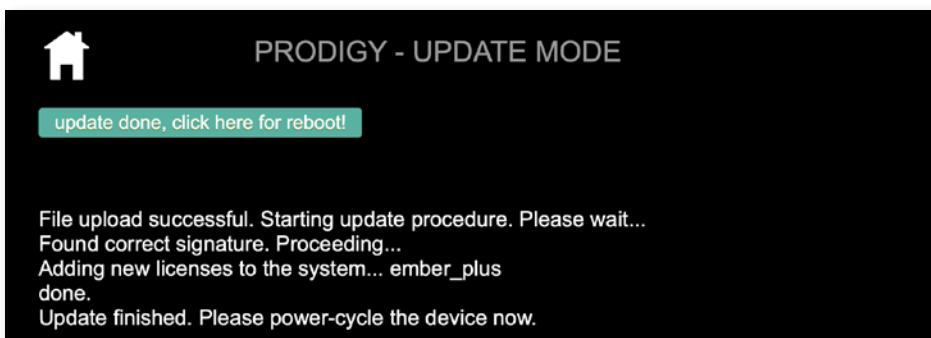

8. Check the new build version in the SETTINGS DEVICE INFO.

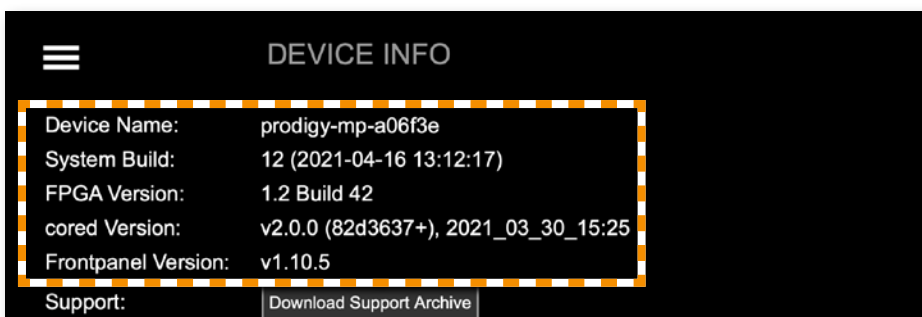

DirectOut GmbH

Hainichener Str. 66a
09648 Mittweida
Germany

T: +49-3727-5650-00
M: info@directout.eu
www.directout.eu