

RAV.IO

User's Manual

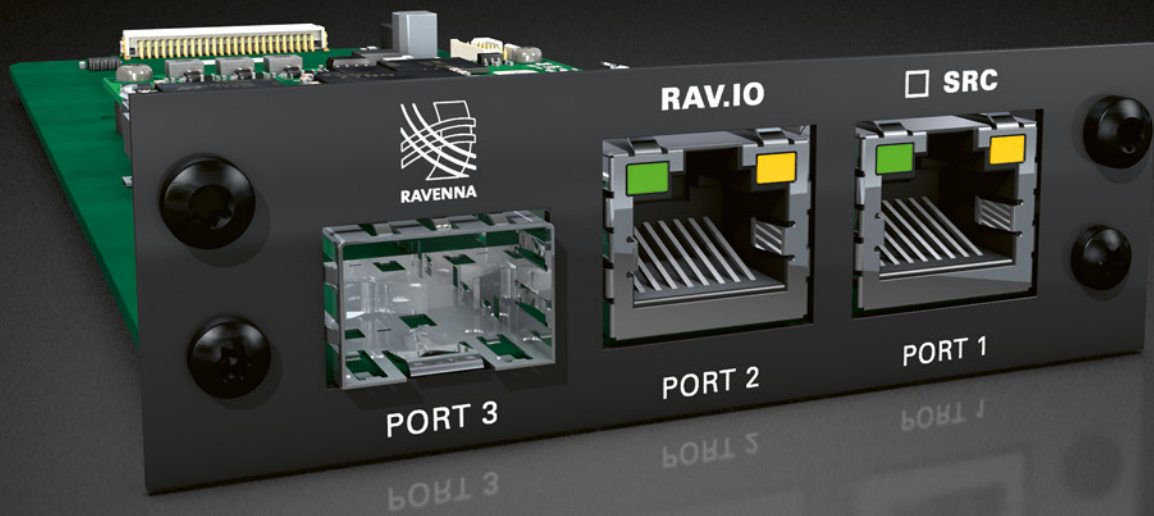

Copyright

All rights reserved. Permission to reprint or electronically reproduce any document or graphic in whole or in part for any reason is expressly prohibited, unless prior written consent is obtained from the DirectOut GmbH.

All trademarks and registered trademarks belong to their respective owners. It cannot be guaranteed that all product names, products, trademarks, requisitions, regulations, guidelines, specifications and norms are free from trade mark rights of third parties.

All entries in this document have been thoroughly checked; however no guarantee for correctness can be given.

DirectOut GmbH cannot be held responsible for any misleading or incorrect information provided throughout this manual.

DirectOut GmbH reserves the right to change specifications at any time without notice.

DirectOut Technologies® is a registered trademark of the DirectOut GmbH.

© DirectOut GmbH, 2024

Table of contents

RAV.IO	4
Introduction	4
Connecting Audio Network	5
Status - Overview	5
Status - Sync	6
Status - Network	8
Status - Device	10
Status - Input Streams.....	12
Status - Output Streams.....	22
Advanced - Overview	26
Advanced - PTP Settings.....	27
Advanced - PTP Unicast.....	29
Advanced - PTP Profile Customized Settings.....	30
Advanced - Current PTP Master.....	31
Advanced - PTP Statistic	32
Advanced - PTP Clock Setting.....	33
Advanced - Network Advanced Settings	34
Advanced - PTP Jitter.....	35
NMOS - Overview.....	36
NMOS port - NIC1 & NIC2	37
NMOS registry - Search mode	37
NMOS - Additional Settings	38
Logging	40
Statistic.....	42
Switch	43
Tools.....	44
RAV.IO - Firmware Update	49
Index	50

RAV.IO

Introduction

RAV.IO is an audio network module for RAVENNA / AES67. It is hosted in a PRODIGY mainframe.

All functions are accessible through a browser based interface (html5 / javascript).

The size of the window and the zoom level can be varied. The page is organized in tabs, pulldown menus or hyperlinks offer access to the values of a parameter.

Some values use an input field (e.g. IP address).

The screenshot displays the RAV.IO web interface with the following sections:

- Navigation Tabs:** STATUS (selected), ADVANCED, NMOS, LOGGING, ABOUT, STATISTIC, SWITCH, TOOLS.
- SYNC Panel:**
 - PTP: (selected), Ext:
 - Clock master: PTP (dropdown)
 - Sample rate: 48 kHz (dropdown)
 - PTP state: master
 - PTP jitter: 0.00 us
 - PTP offset: 0.00 us
 - RTP state: ok
 - Audio engine: RX state , TX state
- NETWORK Panel:**
 - Name: RAV-SRC-IO
 - NIC 1: (selected)
 - MAC address: A0-BB-3E-20-09-C4
 - IP address: 192.168.72.82
 - NIC 2:
 - MAC address: A0-BB-3E-20-09-C5
 - IP address: 192.168.72.24
 - Sync: internal
 - GMID: A0-BB-3E-FF-FE-20-09-C4
- DEVICE Panel:**
 - Temp CPU: 57 °C
 - Temp switch: 41 °C
 - Settings, Load preset, Save preset (links)
- INPUT STREAMS:** A list of 16 streams (01-16), each with an 8 ch status indicator and a play/pause button.
- OUTPUT STREAMS:** A list of 16 streams (01-16), each with an 8 Ch status indicator and a play/pause button.



NOTE

Refers to module software: SW 0.94 / HW 0.29

Connecting Audio Network

To access the control page:

- connect the network with one port
- enter `http://<IP Address>` (default IP @ PORT 1: 192.168.0.1) in the navigation bar of your browser

The three physical network ports (Port 1 to 3) are managed by two independent internal network interfaces (NIC 1 / NIC 2).

Port 1 is fixed assigned to NIC 1.

Port 2 and 3 can be assigned to either NIC 1 or NIC 2 on the SWITCH tab - see p 43.

NOTE



If NIC 1 and NIC 2 are connected to the same switch, they must be configured to different subnets - see "Network Settings" on page 9.

Status - Overview

The tab 'STATUS' is divided into several sections:

- SYNC - monitoring sync state, clock selection, links to I/O settings
- NETWORK - display network info, link to network settings
- DEVICE - monitoring device info, link to device settings, phones level control
- INPUT STREAMS - monitoring and control input streams, link to input stream settings
- OUTPUT STREAMS - monitoring and control output streams, link to output stream settings

Hyperlinks open a popup window to adjust related settings. Most settings are updated immediately without further notification. To exit a popup window click the button in the top right corner.

Mouse overs are used to display further information (e.g. connection speed of network link).

NOTE



The web user interface updates itself when changes are applied by other instances (other browsers, external control commands).

Status - Sync

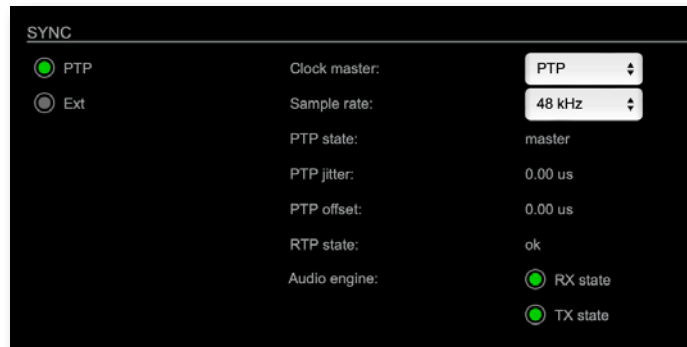

PTP, Ext	Displays clock source and state for the main frame: <input type="radio"/> (OFF) = not locked <input checked="" type="radio"/> (ON) = locked and in sync with clock master <input type="radio"/> (blinking) = locked but not in sync with clock master
Clock master	Pulldown menu to select clock source of the main frame (PTP, extern)
Sample rate	Pulldown menu to adjust sample rate of the main frame (44.1 / 48 / 88.2 / 96 / 176.4 / 192 kHz).
PTP state	State of PTP (Master / Slave).
PTP jitter	PTP-clock jitter per second
PTP offset	Offset relative to PTP-clock master
RTP state	Status of packet processing (OK, Error*)
Audio engine RX state	State of module's audio engine- receiving <input checked="" type="radio"/> (ON) = ok, receiving data <input type="radio"/> (blinking) = not all received packets can be processed
Audio engine TX state	State of module's audio engine- sending <input checked="" type="radio"/> (ON) = ok, sending data <input type="radio"/> (blinking) = not all packets can be sent to the network

* Error: packet time stamps are out of bounds.

Possible reasons: stream offset may be too small or transmitter or receiver are not synced properly to the Grandmaster.

Hyperlinks:

- [PTP / PTP state \(p 7\)](#)

PTP Settings

PTP Input	NIC selection for PTP clock input. 'NIC 1 & 2' means input redundancy.
IP Mode	PTP via multicast, unicast or in hybrid mode. *
Mode	PTP-clock master / slave configuration is auto negotiated between devices in the network. Module's master / slave state may change automatically.
Profile	PTP profile selection (default E2E, default P2P, media E2E, media P2P, customized)
Customized profile	Edit opens the tab 'ADVANCED' to adjust the custom profile.

See „Advanced- PTP Clock Setting“ on page 33 for more details.

Status - Network

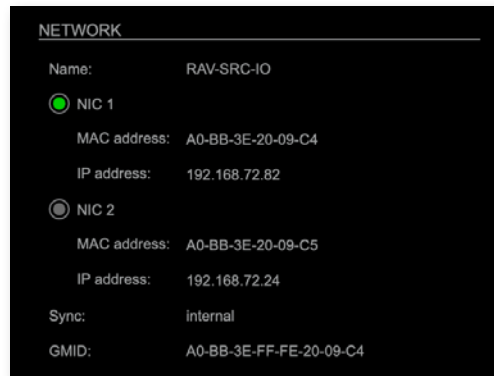

Name	Module's name in the network. Used e.g. for mDNS service. The name needs to be unique throughout the network.
NIC 1 / NIC 2	Monitoring state of network interface controller <input type="radio"/> (OFF) = not connected <input checked="" type="radio"/> (ON) = connected with the network
MAC address	Hardware identification of network interface controller.
IP address	IP address of device
Sync	Selected NIC for PTP sync
GMID	Grand Master ID (PTP)

Hyperlinks

- Name / IP address (p 9)

Mouse over:

- LED NIC 1- indicating link state and connection speed
- LED NIC 2- indicating link state and connection speed



NOTE

If NIC 1 and NIC 2 are connected to the same switch, they must be configured to different subnets - see "Network Settings" on page 9.

Network Settings

The two network interface controllers (NIC 1 / NIC 2) are configured individually.

The screenshot displays the network configuration interface for two Network Interface Controllers (NIC 1 and NIC 2). Each NIC has a section for IP address configuration and a section for direct routing (multicast transfer only).

NIC 1 Configuration:

- Dynamic IP address (IPv4):
- Static IP address (IPv4):
 - IP address (IPv4): 192.168.72.82
 - Subnet mask (IPv4): 255.255.255.0
 - Gateway (IPv4): 0.0.0.0
 - DNS server (IPv4): 0.0.0.0

NIC 2 Configuration:

- Dynamic IP address (IPv4):
- Static IP address (IPv4):
 - IP address (IPv4): 169.254.61.155
 - Subnet mask (IPv4): 255.255.0.0
 - Gateway (IPv4): 0.0.0.0
 - DNS server (IPv4): 0.0.0.0

Direct routing (multicast transfer only):

For both NICs, there are 10 checkboxes labeled "Host IP address 1" through "Host IP address 10". For NIC 1, the first checkbox is checked and its value is 172.44.56.12. For NIC 2, all checkboxes are unchecked and their values are 0.0.0.0.

An "Apply" button is located at the bottom center of the configuration area.

Device name	Input field - Module's name in the network. Used e.g. for mDNS service. The name needs to be unique throughout the network.
Dynamic IP address (IPv4)	Switch to enable the device's DHCP client. IP address is assigned by DHCP server. If no DHCP is available the IP address is determined via Zeroconf.
Static IP address (IPv4)	Switch to disable the device's DHCP client. Manual configuration of network parameters.
IP address (IPv4)	Module's IP Address
Subnet mask (IPv4)	Module's subnet mask
Gateway (IPv4)	IP address of gateway
DNS server (IPv4)	IP address of DNS server
Apply	Button to confirm changes. Another popup window will appear to confirm a reboot of the module.
Direct routing	IP addresses of devices outside the subnet, to enable multicast traffic; e.g. Grandmaster or IGMP querier. Mark checkbox to activate.

Status - Device

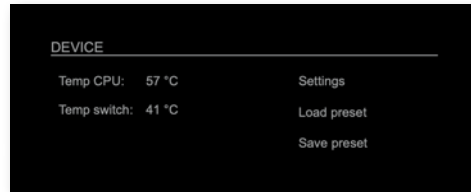

Temp CPU	Display temperature of CPU core in degree Celsius. It may reach 95 °C without effecting the performance of the device.
Temp switch	Display temperature of network switch in degree Celsius
Settings	Opens a popup window to configure the device.
Load preset	Opens a dialog to store the device settings to a file. Filetype: .rps
Save preset	Opens a dialog to restore the device settings from a file. Filetype: .rps

Hyperlinks:

- [Settings \(p 10\)](#)
- [Load preset \(p 11\)](#)
- [Save preset](#)

Settings

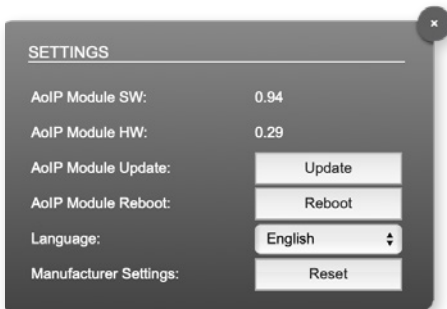

AoIP Module SW	Module's software version. It is updated together with hardware version via network.
AoIP Module HW	Module's bitstream version. It is updated together with software version via network.
AoIP Module Update	Opens a dialog for selection of the update file - see "RAV.IO- Firmware Update" on page 49.
AoIP Module Reboot	Restart of the AoIP module. Confirmation required. Audio transmission will be interrupted.
Language	Menu language (english, german).
Manufacturer Settings Reset	Restore device settings to factory defaults. Confirmation required.

Load Preset

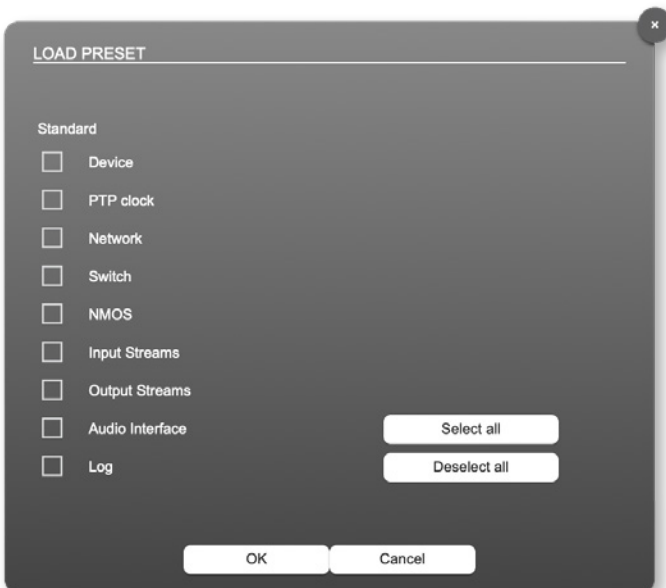

The device configuration can be stored to a single file (.rps). Restoring the configuration a dialog prompts for selection of individual settings. This enhances flexibility at setup changes when a particular adjustment shall be preserved or just a single adjustment shall be restored.

Status - Input Streams

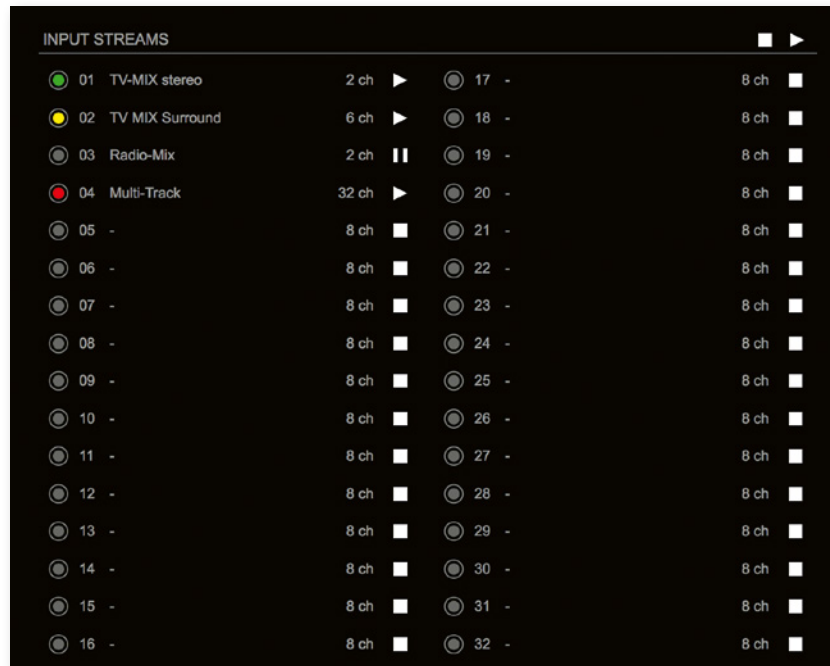











The module can subscribe up to 32 streams. The overview displays the basic information of each stream. The input stream name can be set manually (discovery protocol: manually, see page p 21) overriding the SDP's stream name information.

A backup stream can be defined as source after an adjustable timeout. A central active / inactive switch allows to toggle the stream state of all input streams at once.

01 to 32	<p>State of incoming streams</p> <ul style="list-style-type: none"> <input type="radio"/> (OFF) = stream not activated <input checked="" type="radio"/> (ON) = stream activated, receiving data <input checked="" type="radio"/> (ON) = stream activated, receiving data via one NIC only (input redundancy) <input checked="" type="radio"/> (blinking) = stream activated, not receiving data (unicast, connection not established)
01 to 32 Name	Name of stream gathered from SDP or set manually in the stream settings dialog.
01 to 32 xx ch	Number of audio channels transported by the stream



<p>01 to 32</p> <p>    </p>	<p>Click to activate or deactivate single stream.</p> <p>  = stream activated  = stream deactivated  = stream not active, defined as backup-stream </p>
<p>INPUT STREAMS</p> <p>   </p>	<p>Click to activate or deactivate all streams.</p> <p>  = activate all streams  = deactivate all streams (requires confirmation) </p>

Backup Streams

01 - INPUT STREAM SETTINGS

Activate Stream:

Stream Input:

Backup Stream:

Backup Stream Timeout:

Example:

Backup stream (input 3) that will act as source in the audio matrix if the current session (input 1) fails. Switch-over occurs after the defined timeout (1s).

Stream 3 is marked accordingly in the status view

INPUT STREAMS				■ ▶
01	TV-MIX stereo	2 ch	■	17 -
02	TV MIX Surround	6 ch	▶	18 -
03	Radio-Mix	2 ch	▶	19 -
04	Multi-Track	32 ch	▶	20 -
				8 ch ■
				8 ch ■
				8 ch ■
				8 ch ■

Input 1 failed and Input 3 becomes active after the timeout.



NOTE

In case the main input fails the main stream is stopped (IGMP LEAVE) before the backup stream is being activated. This behaviour ensures that the required network bandwidth does not increase in case of a failure.

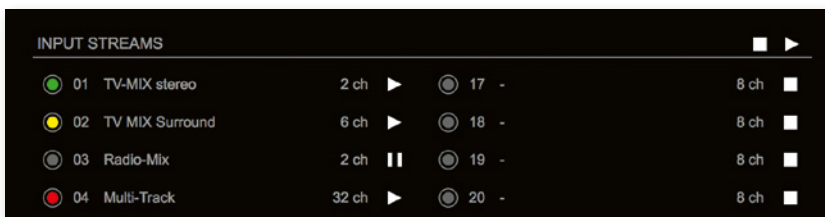

INPUT STREAMS					
01	TV-MIX stereo	2 ch	▶	17 -	8 ch
02	TV MIX Surround	6 ch	▶	18 -	8 ch
03	Radio-Mix	2 ch	⏸	19 -	8 ch
04	Multi-Track	32 ch	▶	20 -	8 ch

Hyperlinks:

- Name (p 16)

Mouse over:

- LED- indicating stream state

NOTE



Source-Specific Multicast (SSM) support for IGMP v3, v2 and v1 (SSM via protocol only in IGMP v3, SSM via internal filtering is applied for IGMP v2 and v1) - see "Source Specific Multicast" on page 21.

Input Stream Settings

01 - INPUT STREAM SETTINGS

Activate Stream:

Stream Input: NIC 2

Backup Stream: disabled

Backup Stream Timeout: 1s

Stream name: Stage A

Stream state: connected

Stream state messages:

Stream state offset max (samples): 8

Stream state offset min (samples): 2

Stream state ip address src NIC 1 / NIC 2: - / 239.69.1.2

Stream state connection lost (Events) NIC 1 / NIC 2: 0 / 0

Stream state packet lost (Events) NIC 1 / NIC 2: 0 / 0

Stream state wrong timestamp (Events) NIC 1 / NIC 2: 0 / 0

Offset fine:

Offset in samples: 128 (2.67 ms)

Start channel: 1

Discovery protocol: RTSP (RAVENNA Session)

Session NIC 1: ↓

Session NIC 2: ↓

Up to 32 input streams can be subscribed. Each stream is organized in a 'RAVENNA session' (SDP = Session Description Protocol) that describes the stream parameters (audio channels, audio format, etc.).

The stream settings allow to adjust the processing of the received audio data (offset, signal routing). The receiving of stream data starts once the stream has been enabled.

The settings displayed vary depending on the selected discovery protocol.



TIP

A sample offset of at least doubled packet time (samples per frame) is recommended

Example: Samples per frame = 16 (0.333 ms) ⇨ Offset ≥ 32 (0.667 ms)

It may be helpful to alter the stream discovery protocol if an expected stream can't be discovered by the device.

Activate stream	Stores parameters and activates or deactivates the receiving of audio data. (Unicast: additionally the negotiation of the connection)
Stream input	Selects one or both NICs used for stream input. Both NICs means input redundancy.
Backup Stream	Selects a backup stream that will act as source in the audio matrix if the current session fails. Switch-over occurs after the defined timeout.
Backup Stream Timeout	Defines timeout [1 s to 120 s] before switch-over to backup stream.
Stream name	Name of stream gathered from SDP
Stream state	Information about stream state: connected not connected receiving data read successfull error
Stream state message	Status info related to stream state.
Stream state offset max	Measured value (maximum). A high value indicates that the media offset of the source might not match the adjusted media offset of the device.
Stream state offset min	Measured value (minimum). The offset should not become negative.
Stream state ip address src NIC 1 / NIC 2	Multicast address of input stream subscribed at NIC 1 / NIC 2. Unicast transmission: IP address of sender.
Stream state connection lost NIC 1 / NIC 2	counter indicates the number of incidents where the network connection was lost (link down)
Stream state packet lost (Events) NIC 1 / NIC 2	counter indicates the number of lost RTP packets
Stream state wrong timestamp (Events) NIC 1 / NIC 2	counter indicates the number of packets with invalid timestamp
Offset fine	Enables adjustment of offset in increments of one sample.
Offset in samples	Modules output delay of received audio data (input buffer).

Start channel	Assignment of first stream channel in the audio matrix. E.g. stream with two channels, starting at channel 3 is available at channel 3 & 4 of the routing matrix.
Discovery protocol	Connection protocol or manual setup. RTSP = Real Time Streaming Protocol SAP = Session Announcement Protocol
Session NIC 1	Selection of discovered streams at NIC 1
Session NIC 2	Selection of discovered streams at NIC 2

Stream Discovery in AoIP environments is a colorful mixture of different mechanisms. To serve a successful stream management RAV.IO provides a bunch of options, not making operation easier but effective.

Discovery protocol: RTSP (RAVENNA Session) ↓

Session NIC 1: ↓

Session NIC 2: ↓ Refresh

Discovery RTSP (Session)

Discovery protocol: RTSP (RAVENNA Session) ↓

Session NIC 1: ↓

Session NIC 2: ↓

Discovery RTSP (URL)

Discovery protocol: RTSP (RAVENNA URL) ↓

URL NIC 1:

URL NIC 2: Receive SDP

URL	URL (Uniform Resource Locator) of the session of the device that is serving streams. Examples: rtsp://192.168.74.44/by-id/1 or rtsp://PRODIGY-RAV-IO.local:80/by-name/Stage_A
Receive SDP	Recalls the stream configuration of the defined session(s).

NOTE

In case the automatic stream announcement and discovery of RAVENNA streams fails or cannot be used in a given network, the stream's SDP file can also be obtained via an RTSP URL.



Discovery SAP

SAP is used in Dante environments.

Discovery NMOS

Session	[MAC Address of sender] stream name @NIC
Refresh	Initiates a scan for available streams.

NMOS is suited for use in SMPTE ST 2110 environments.

Manual Setup

Discovery protocol: Manual configuration

Stream name (manual):

Number of channels:

RTP payload ID:

Audio format: L24

Media offset:

NIC 1

Dst IP address:

SSM (Source Specific Multicast):

Src IP address:

RTP dst port:

RTCP dst port:

NIC 2

Dst IP address:

SSM (Source Specific Multicast):

Src IP address:

RTP dst port:

RTCP dst port:

Stream name (manual)	Stream name for display in status view and matrix. Can be specified individually, different than the name gathered from the SDP.
Number of channels	Number of audio channels in the stream
RTP-Payload-ID	RTP-Payload-ID of the audio stream (Real-Time Transport Protocol). Describes the format of the transported content.
Audio Format	Stream's audio format (L16 / L24 / L32 / AM824)
Media Offset	Offset between stream's timestamp and PTP-clock
Dst IP address	Multicast IP address of audio stream
SSM	Activate Source Specific Multicast filter for this stream.*
Src IP address	IP address of sending device.*
RTP dst port	Stream's destination port for RTP
RTCP dst port	Stream's destination port for RTCP (Real-Time Control Protocol)

* An RTP packet contains the IP address of the sender (source IP) and the stream's multicast address (destination IP). With SSM activated the receiver only accepts RTP packets of a certain destination IP that are originated by a sender with the specified source IP.

NOTE



RTP Payload ID must match between sender and receiver.

Status - Output Streams

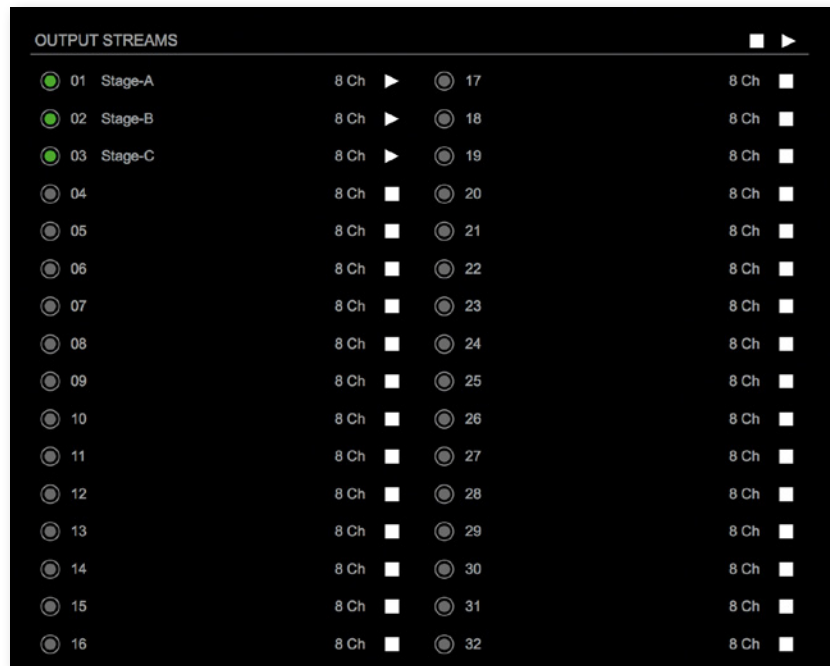

The device can send up to 32 streams. The overview displays the basic information of each stream.

01 to 32	<p>State of outgoing streams</p> <ul style="list-style-type: none"> <input type="radio"/> (OFF) = stream not activated <input checked="" type="radio"/> (ON) = stream activated, sending data <input checked="" type="radio"/> (ON) = stream activated, stream output via both NICs selected, but one NIC is not linked to the network.
01 to 32 Name	Name of stream defined in the settings
01 to 32 xx ch	Number of audio channels transported by the stream
01 to 32 ■ ▶	<p>Activate or deactivate stream.</p> <ul style="list-style-type: none"> ▶ = stream activated ■ = stream deactivated
OUTPUT STREAMS ■ ▶	<p>Click to activate or deactivate all streams.</p> <ul style="list-style-type: none"> ▶ = activate all streams ■ = deactivate all streams (requires confirmation)

Hyperlinks:

- Name (p 24)

Mouse over:

- LED- indicating stream state

TIP



AES67 Streams

To create output streams for interoperability in AES67 environments please consult the information document [Info- AES67 Streams](#).

TIP



SMPTE 2110-30 /-31 Streams

To create output streams for interoperability in SMPTE ST 2110 environments please consult the information document [Info- ST2110-30 Streams](#).

Both documents are available at <http://academy.directout.eu>.

Output Stream Settings

02 - OUTPUT STREAM SETTINGS

Activate Stream:

Stream Output: NIC 2

Stream name (ASCII): Ambience

RTSP URL (HTTP tunnel) (by-name): rtsp://PRODIGY-RAV-IO-20079e.local:80/by-name/Ambience
 RTSP URL (HTTP tunnel) (by-id): rtsp://PRODIGY-RAV-IO-20079e.local:80/by-id/2
 RTSP URL (by-name): rtsp://PRODIGY-RAV-IO-20079e.local/by-name/Ambience
 RTSP URL (by-id): rtsp://PRODIGY-RAV-IO-20079e.local/by-id/2

SDP:

v=0
 o=- 2 2482002937 IN IP4 192.168.74.44
 s=Ambience
 t=0 0
 m=audio 5004 RTP/AVP 98

Unicast:

RTP payload ID: 98

Samples per Frame (packet time): 45 (0.94 ms)

Audio format: AM824

Start channel: 9

Number of channels: 8

NIC 1	NIC 2
RTP dst port: 5004	RTP dst port: 5004
RTCP dst port: 5005	RTCP dst port: 5005
Dst IP address (IPv4): 239.69.1.3	Dst IP address (IPv4): 239.69.1.4

Up to 32 output streams can be sent to the network. Each stream is organized in a session (SDP = Session Description Protocol) that describes the stream parameters (audio channels, audio format, etc.).

Each stream may be labelled with an individual stream name (ASCII) which is useful for enhanced comfort at organizing the setup.

The stream settings allow to adjust the processing of the sent audio data (blocks per frame, format, signal routing, ...). The sending of stream data starts once the stream has been enabled.

Once the stream is active, the SDP data is displayed and may be copied from the window or downloaded via <http://<rav-io>/sdp.html?ID=<stream no.>>.

Activate stream	Stores parameters and activates or deactivates the receiving of audio data. (Unicast: additionally the negotiation of the connection)
Stream Output	Selects one or both NICs used for stream output. Both NICs means output redundancy.
Stream name (ASCII)	Individually defined name of an output stream. It is used in the URL which is indicated in different ways below.*
RTSP URL (HTTP tunnel) (by-name) / (by id)	Current used RTSP-URL of stream with HTTP port used for RTSP, stream name or stream id.
RTSP URL (by-name) / (by id)	Current used RTSP-URL of stream with stream name or stream id.
SDP	SDP data of the active stream.
Unicast	If activated, the stream is sent in unicast mode.**
RTP payload ID	Stream's payload id
Samples per Frame	Number of blocks containing payload (audio) per ethernet frame - see packet time on p 16.
Audio format	Stream's audio format (L16 / L24 / L32 / AM824) ***
Start channel	Assignment of first stream channel from the audio matrix. E.g. stream with eight channels, starting at channel 3 is fed from channel 3 to 10 of the routing matrix.
Number of channels	Number of audio channels in the stream.
RTP dst port	Stream's destination port for RTP
RTCP dst port	Stream's destination port for RTCP (Real-Time Control Protocol)
Dst IP address (IPv4)	Stream's IP address for multicast (should be unique for each stream).

* Only ASCII characters are allowed.

** A unicast stream can only be received by one device. If a device is already receiving the stream, further connection calls by other clients are answered with 'service unavailable' (503). The release time after disconnect or interruption of the client's connection amounts to about 2 minutes.

*** L16 = 16 bit audio / L24 = 24 bit audio / L32 = 32 bit audio /
AM824 = standardized according to IEC 61883, allows AES3 transparent transmission (SMPTE ST 2110-31).

Advanced - Overview

The screenshot displays the 'ADVANCED' tab of the RAV.IO configuration interface. It is organized into several sections for PTP (Precision Time Protocol) management:

- PTP SETTINGS:** Includes fields for PTP Input (NIC 2), IP mode (Multicast), Mode (auto), and Profile (media E2E).
- PTP CURRENT SETTINGS:** Configures clock class (248), accuracy (254), clock domain (NIC 1: 0, NIC 2: 1), priorities (1: 128, 2: 128), announce (2 s), sync (125 ms), and delay mechanisms (E2E).
- PTP UNICAST:** Shows Auto Detect GM (on), Grant duration (30), and Grandmaster IP (0.0.0.0).
- CURRENT PTP MASTER:** Displays clock class (248), accuracy (254), clock domain (1), priorities (64), GMID (A0-BB-3E-FF-FE-20-0B-85), sync (NIC 2), and IPv4 (192.168.74.58).
- PTP STATISTIC:** Shows PTP state (slave), jitter (0.48 us), offset (-0.08 us), and master/slave delays (0s 4148ns and 0s 4240ns).
- PTP CLOCK SETTINGS:** Configures No PTP switch 1/2 (0 Gbit/s, 0 Mbit/s).
- NETWORK ADVANCED SETTINGS:** Includes IGMP NICs (auto), TCP/RTSP ports (80, 554, 128), DSCP RTP/PTP packets (AF41, CS6), and various announcement options (MDNS, SAP, Multicast audio loopback, Multicast RTCP).
- PTP JITTER:** A graph showing jitter fluctuations over time, ranging from -5057 ns to 5057 ns.

The tab 'ADVANCED' is divided into several sections:

- PTP SETTINGS - definition of PTP source, mode and profile
- PTP PROFILE CURRENT SETTINGS - definition of a customized PTP profile
- CURRENT PTP MASTER - monitoring PTP characteristics
- PTP STATISTIC - monitoring device's PTP state, jitter and delay
- PTP CLOCK SETTINGS - definition of adaption algorithms to reduce jitter
- NETWORK ADVANCED SETTINGS - definition of network and QoS characteristics
- PTP JITTER - graphical display of measured PTP jitter

Advanced - PTP Settings



PTP Input	Selects one or both network ports used for PTP input. Both ports means input redundancy. *
IP Mode	<p>Multicast = Sync messages and delay request are sent as multicast message to every node within the network.</p> <p>Hybrid = Sync messages are sent as multicast, delay requests are sent as unicast messages directly to the Grandmaster or Boundary Clock. **</p> <p>Unicast = Sync messages are sent as unicast, delay requests are sent as unicast messages directly to the Grandmaster or Boundary Clock. ***</p>

- * Using redundant PTP-operation a switch-over is triggered not only at signal loss of the Grandmaster but depends on the quality of the PTP clock. Changes (e.g. clock class) are observed permanently and the algorithm decides for the best signal present.
- ** Hybrid Mode reduces the workload for all nodes in the network as they do not receive the (unnecessary) delay requests from other devices anymore.
- *** Unicast Mode may help when multicast routing is not possible within the network. As an opposite to the Hybrid Mode it increases the workload of the grandmaster since sync messages must be sent to each single slave individually.

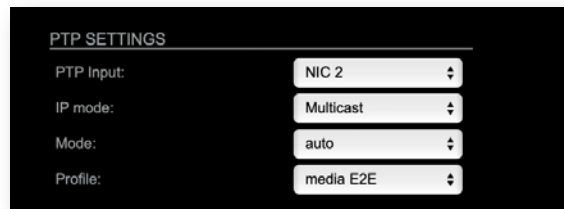

Mode	<p>auto = PTP-clock master / slave configuration is auto negotiated between devices in the network. Module's master / slave state may change automatically.</p> <p>slave only = PTP-clock slave configuration is preferred. Module clocks to another device in the network</p> <p>preferred master = PTP-clock master configuration is preferred. Module acts as network grandmaster. Priority values are adjusted automatically to ensure Grandmaster status. *</p> <p>master only = PTP-clock master is forced. **</p>
Profile	Selects predefined PTP profile (default E2E, default P2P, media E2E, media P2P) or activates customized PTP profile.

* If more than one device announces as PTP-clock master the network Grandmaster is determined following the Best Master Clock Algorithm (BMCA).

** 'Master only' configures the device to act as Unicast Grandmaster. This setting is available only with PTP Mode set to 'unicast'



NOTE

PTP profile ,customized' allows for individual adjustment of the PTP parameters. If profile is set to ,media' or ,default' the PTP parameters cannot be altered and are displayed only. Factory default setting is PTP Media Profile E2E.

Advanced - PTP Unicast

PTP UNICAST

Auto Detect GM: on

Grant duration (sec): 30

Grandmaster IP: 0.0.0.0

Auto Detect GM	on = enables the automatic detection of the grandmaster * off = IP address of grandmaster needs to be defined manually
Grant duration (sec)	Time period during which the slave receives sync messages from the grandmaster.**
Grandmaster IP	IP address of the grandmaster.***

* 'Auto Detect GM' is a proprietary function and might not be supported by 3rd party GMs.

** Depending on the temporary workload of the grandmaster the negotiation may fail.

*** This value is used only with 'Auto Detect GM' set to <off>.

About PTP Unicast

Since the BMCA is not available with PTP unicast, the PTP properties of the devices require some extra configuration.

Example:

Grandmaster	IP Mode Unicast, Mode Master only
Slave(s)	IP Mode Unicast, Mode Slave Only, Auto Detect GM ON, Grant Duration 30 sec

Advanced - PTP Profile Customized Settings

```

PTP CURRENT SETTINGS
Clock class: 248
Accuracy: 254
Clock domain NIC 1: 0
Clock domain NIC 2: 1
Priority 1: 128
Priority 2: 128
Announce: 2 s (1)
Sync: 125 ms (-3)
Min delay request: 1 s (0)
Min pdelay request: 1 s (0)
Announce receipt timeout: 3
One step clock: no
Slave only: no
Delay mechanism: E2E
    
```

The settings become available with PTP profile set to 'customized'.

Clock class	PTP-clock's class according to IEEE 1588 [read only]
Accuracy	PTP-clock's accuracy according to IEEE 1588 [read only]
Clock domain NIC 1	PTP-clock's domain at NIC 1
Clock domain NIC 2	PTP-clock's domain at NIC 2
Priority 1	Priority setting for master announcement (the smaller the value the higher the priority)
Priority 2	If value 'Priority1' (and other PTP-clock parameters) of more than one device in the network match: Priority setting for master announcement (the smaller the value the higher the priority)
Announce	Intervall of sending announce-packets for auto-negotiation.
Sync	Intervall of sending sync-packets to the PTP-clock slaves in the network.
Min delay request	Intervall of sending End-To-End packets of PTP-clock slave to PTP-clock master. To determine the offset slave-to-master.
Min pdelay request	Intervall of sending Peer-To-Peer packets between two PTP-clocks. To determine the offset master-to-slave and slave-to-master.
Announce receipt timeout	Number of missed announce-packets (threshold) to reinitialize the negotiation of PTP-clock master.

One step clock	Timestamp of PTP-clock is integrated in PTP-sync-packets. No follow-up packets are sent. No = Two step clock is used
Slave only	Yes = PTP-clock is always slave.
Delay mechanism	E2E - Offset slave-to-master is determined by End-To-End packets. P2P - Offset master-to-slave and slave-to-master is determined by Peer-To-Peer packets.

Advanced - Current PTP Master

```

CURRENT PTP MASTER
Clock class:      248
Accuracy:        254
Clock domain:    1
Priority 1:       64
Priority 2:       64
GMID:            A0-BB-3E-FF-FE-20-0B-86
Sync:            NIC 2
IPv4:            192.168.74.58

```

Monitoring display only.

Clock class	PTP-clock's class according to IEEE 1588
Accuracy	PTP-clock's accuracy according to IEEE 1588
Clock domain	PTP-clock's domain at selected NIC
Priority 1	Priority setting for master announcement (the smaller the value the higher the priority)
Priority 2	If value 'Priority1' (and other PTP-clock parameters) of more than one device in the network match: Priority setting for master announcement (the smaller the value the higher the priority)
GMID	ID of current Grandmaster
Sync	Selected NIC for PTP clock
IPv4	IP address of Grandmaster

Advanced - PTP Statistic

```

PTP STATISTIC
PTP state:          slave
PTP jitter:         0.46 us
PTP offset:         -0.08 us
PTP master to slave: 0s 4148ns
PTP slave to master: 0s 4240ns
Current PTP time (TAI): 1970-01-01 00:30:39
Current PTP time (TAI) (RAW): 1839s 254134455ns
    
```

Monitoring display only.

PTP state	Information about current PTP-clock state: initialize error deactivated receiving data pre master master passive not calibrated slave
PTP jitter	PTP-clock jitter in microseconds (µs)
PTP offset	Offset relative to PTP-clock master
PTP master to slave	Absolute offset master-to-slave in nanoseconds
PTP slave to master	Absolute offset slave-to-master in nanoseconds
Current PTP time (TAI):	Date and time information from GPS source*
Current PTP time (TAI) (RAW):	RAW TAI from GPS source*

* Temps Atomique International- if no GPS source is available for PTP time-stamping, the date / time display starts at 1970-01-01 / 00:00:00 after every reboot of the device.

Advanced - PTP Clock Setting

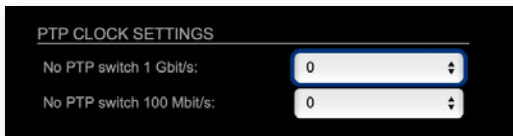

No PTP Switch 1 Gbit/s	Adapted PTP-clock algorithm to reduce clock jitter using 1 GB network switches without PTP support. Max. number of 1 Gbit/s switches: less than 10
No PTP Switch 100 Mbit/s	Adapted PTP-clock algorithm to reduce clock jitter using 100 MB network switches without PTP support. Max. number of 100 Mbit/s switches: 1

Advanced - Network Advanced Settings

IGMP NIC 1	Definition or auto-select of IGMP version used to connect to a multicast router at NIC 1.
IGMP NIC 2	Definition or auto-select of IGMP version used to connect to a multicast router at NIC 2
TCP port HTTP	TCP port for HTTP
TCP port RTSP	TCP port for RTSP
TTL RTP packets	Time-To-Live of RTP packets - default: 128
DSCP RTP packets	DSCP marking of QoS of RTP packets - default: AF41
DSCP PTP packets	DSCP marking for QoS of PTP packets - default: CS6*
Multi stream rx	If activated, the device allows to subscribe to the same multicast stream more than one time - default: off
MDNS announcement	Announcement of streams via MDNS can be controlled to optimize network traffic or CPU load. Values: Off, RX, TX or RX/TX **
SAP announcement	Announcement of streams via SAP can be controlled to optimize network traffic or CPU load. Values: Off, RX , TX or RX/TX **
Multicast audio loopback	
Multicast RTCP	
Network settings Apply	Confirms and saves changes being made. Reboot required.

* AES67 specifies EF, but some implementations use EF for Audio streaming. To avoid overlapping of RTP and PTP packets in the same queue CS6 has been chosen as default.

** RX = receive, TX = transmit, RX/TX = receive and transmit

NOTE

Source-Specific Multicast (SSM) support for IGMP v3, v2 and v1 (SSM via protocol only in IGMP v3, SSM via internal filtering is applied for IGMP v2 and v1) - see "Source Specific Multicast" on page 21.

Advanced - PTP Jitter

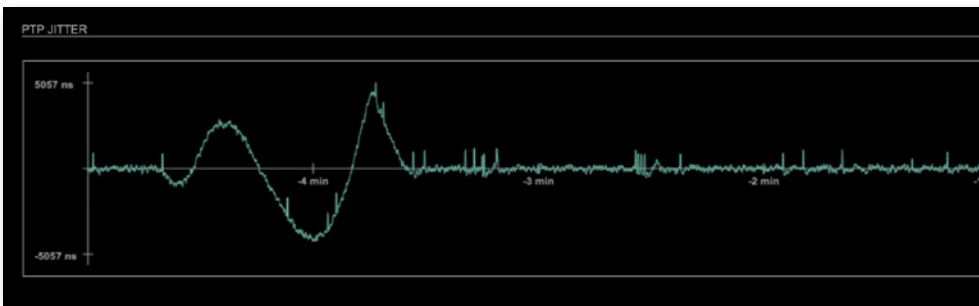

Graphical display of measured PTP jitter.

NOTE

An error message next to Jitter measurement is displayed if delay requests are not being answered by Grandmaster.

NMOS - Overview

The screenshot displays the NMOS configuration page with the following sections:

- Tabs:** STATUS, ADVANCED, **NMOS**, LOGGING, ABOUT, STATISTIC, SWITCH
- NIC1 Settings:**
 - NMOS port: 3210
 - Search mode NMOS registry: Multicast (checked)
 - Unicast: Registry domain name: [empty]
 - Manually: Registry IP address: 0.0.0.0, Registry port: 3210, Version: v1.3
- NIC2 Settings:**
 - NMOS port: 3212
 - Search mode NMOS registry: Multicast (checked)
 - Unicast: Registry domain name: [empty]
 - Manually: Registry IP address: 0.0.0.0, Registry port: 3210, Version: v1.3
- ADDITIONAL SETTINGS:**
 - Disable stream during config: [unchecked]
 - Seed id: e636849f-5674-4508-a907-852bae477796
 - Generate new seed id: [Generate button]
 - Settings (NIC1 + NIC2): [Apply button]
 - Manufacturer Settings NMOS Ports: [Reset button]

NMOS provides a family of specifications related to networked media for professional applications. It is produced by the Advanced Media Workflow Association (AMWA).

Support for NMOS is introduced with the AoIP Module version SW 0.17 / HW 0.46 according to the specifications:

- IS-04 Discovery & Registration
- IS-05 Device Connection Management

IS-04 allows control and monitoring applications to find the resources on a network. Resources include Nodes, Devices, Senders, Receivers, Sources, Flows...

IS-05 provides a transport-independent way of connecting Media Nodes.

More information: <https://specs.amwa.tv/nmos/>

NMOS port - NIC1 & NIC2

The port entries for NIC1 and NIC2 are pre-configured by default. Modifications are possible but not necessary.



NMOS port (NIC1 + NIC2)	Port address. Reboot required after modification.
-------------------------	---

NMOS registry - Search mode

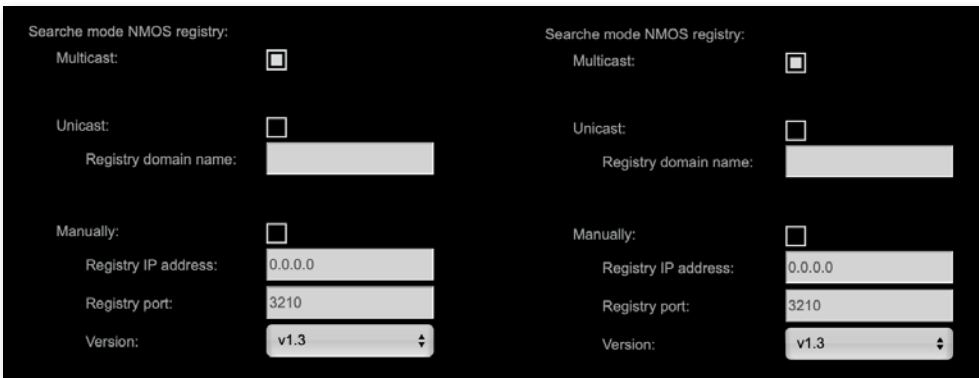

Multicast	use mDNS to determine and connect to the registry server
Unicast	use DNS-SD to connect to the registry server
Registry domain name	DNS resolvable domain name of the registry server
Manually	
Registry IP address	
Registry port	
Version	Support of NMOS API version

NMOS - Additional Settings

Disable stream during config	Automatically disable and re-enable streams when settings are changed via NMOS (recommended)
Seed id	Unique identifier, subordered entities are derived from the seed id.
Generate new seed id Generate	Generates a new unique identifier. Reboot required.

NMOS uses a logical data model based on the JT-NM Reference Architecture to add identity, relationships and time-based information to content and broadcast equipment. Hierarchical relationships group related entities, with each entity having its own identifier.

The identifiers are persistent across restarts of the device in order to make them useful over a period of time longer than a single production deployment.

New identifiers may be generated manually if required.

This page is left blank intentionally.

Logging



The tab 'LOGGING' displays logging depending on the 'Log Settings'. The logging can be enabled individually for different protocols, each of with an adjustable filter. An adjustable log level specifies the information detail of each entry.

To save a log the content of the view can be copied and pasted to a text document.

Log Level

0	log data
1	level and log data
2	protocol, level and log data
3	protocol, process-id of requesting process, process-id of running process, level and log data
4	protocol, process-id of requesting process, process-id of running process, level, processor time in ticks and log data
5	protocol, process-id of requesting process, process-id of running process, level, processor time in ticks, file name and line and log data

Protocol Types

ARP	Address Resolution Protocol
BASE	Basic operation of module
DHCP	Dynamic Host Configuration Protocol
DNS	Domain Name System
FLASH	Process for updating the module
IGMP	Internet Group Management Protocol
MDNS	Multicast Domain Name System
NMOS	Network Media Open Specification
PTP	Precision Time Protocol
RS232	Serial Protocol
RTCP	Real Time Control Protocol
SAP	Session Announcement Protocol
TCP	Transmission Control Protocol
Zeroconf	Zero Configuration Protocol

Log Filter

NONE	logging disabled
ERROR	error occurred
WARNING	warnings- condition that may lead to unwanted behavior or an error
INFO 1	log info* + warning + error
INFO 2	log info* + warning + error
INFO 3	log info* + warning + error
INFO 4	log info* + warning + error

* increasing amount of log info starting from ‚INFO 1‘

Log Operation

Save log	Downloads the current log entries to a text-file (log.txt).
Clear log	Deletes all log entries without further prompt.
Scroll lock	Interrupts automatic scrolling of the list view to allow copying the content to a text file via copy & paste. If scrolling is stopped for a longer period of time the display may not list all entries.

Statistic

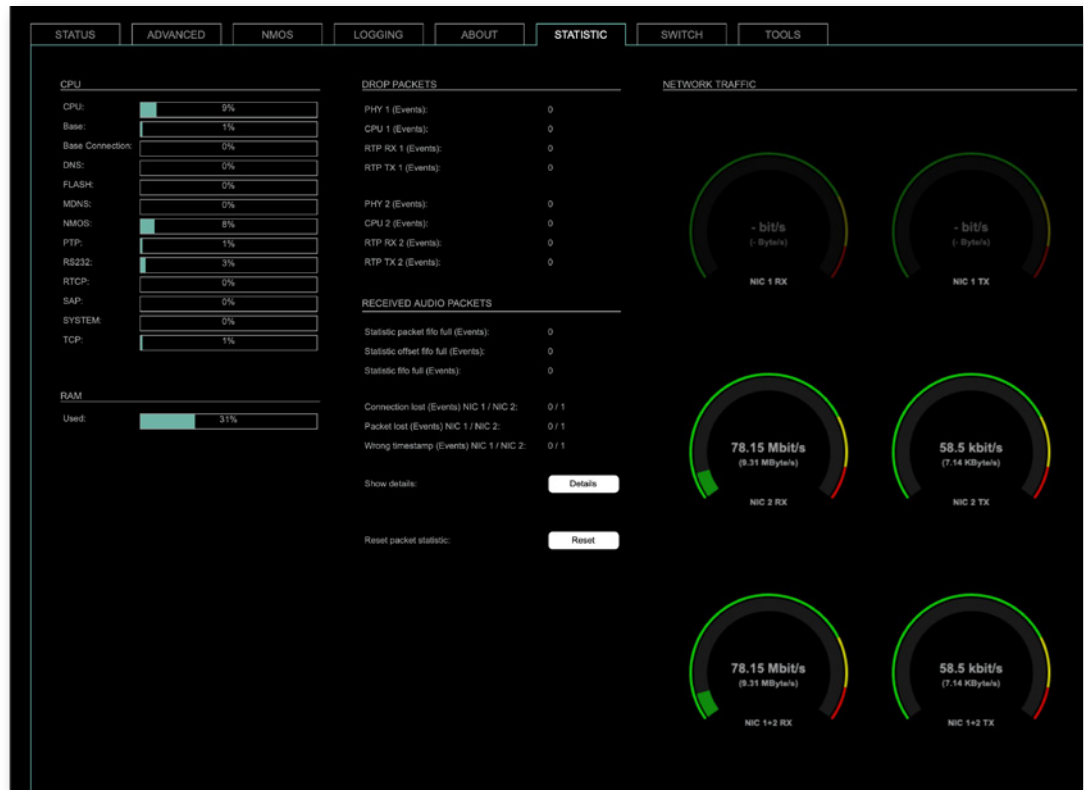

The tab 'STATISTIC' displays an overview of the CPU load of the particular processes, an error counter and a monitor display to indicate the incoming (RX) and outgoing (TX) network traffic on both network ports individually.

Details	Displays a list of input streams and related events (connection lost, packet lost, wrong timestamp) of received audio packets.
Reset	Resets the packet statistic

See "Protocol Types" on page 41.

Switch

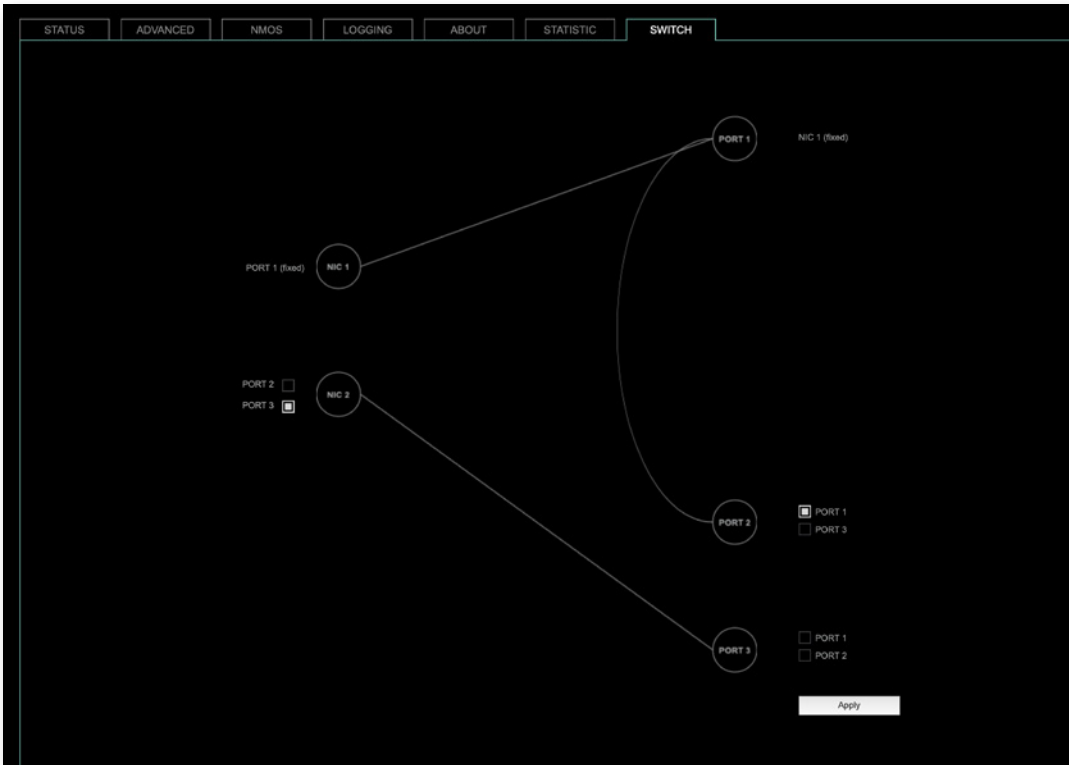

The module features two RJ45 sockets and an SFP cage managed by two independent network interfaces (NIC 1 / NIC 2).

- Port 1 is fixed assigned to NIC 1.
- Port 2 and 3 can be assigned to either NIC 1 or NIC 2 on the SWITCH tab

NOTE

If you want to use a port that is not assigned to a NIC e.g. to patch the device's management port (MGMT) into the audio network, you can link it to one of the audio ports.

NOTE

To access the module's control page it is required to connect the management network to one of the ports that is directly attached to a NIC - see next page.

To give the very best PTP synchronisation performance, the switch incorporates advanced timestamping between the external PORTS and the internal NICs. As a consequence, the on-board switch cannot be used to connect other PTP devices via a single shared connection to the wider network.

Please connect all other PTP devices directly to your system's network switch.

Tools

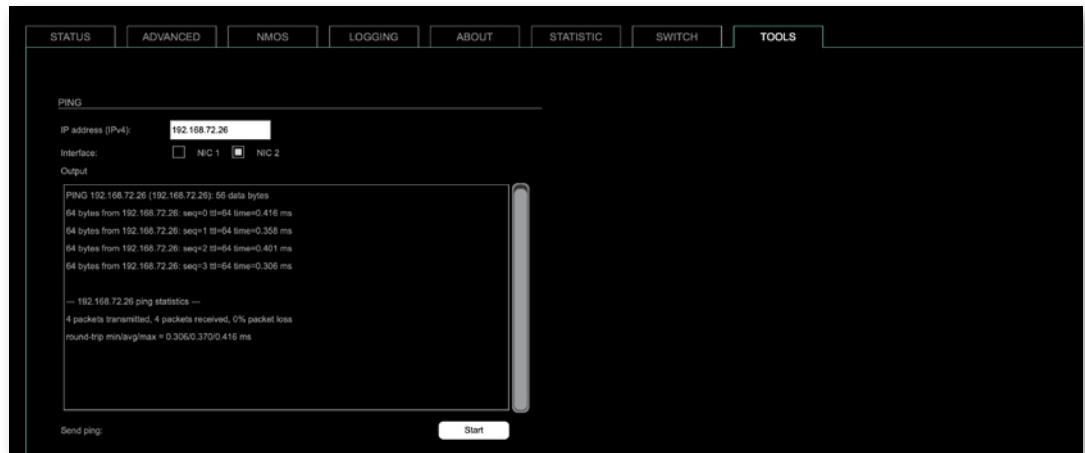

The tab 'TOOLS' offers a generator to ping any IP address (IPv4) from either NIC 1 or NIC 2. The result is displayed at the 'Output'.

IP address (IPv4)	Enter IP address (IPv4) to be pinged
Interface	Select NIC 1 or NIC 2
Start	Sends ping to the specified IP address from selected NIC.

This page is left blank intentionally.

SWITCH - Configurations

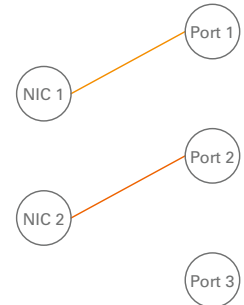
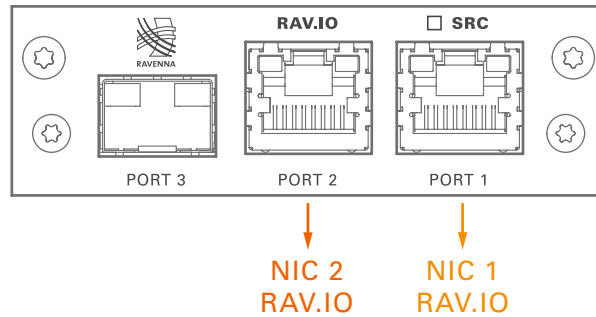

RAV.IO Audio & Control via Port 1 and Port 2

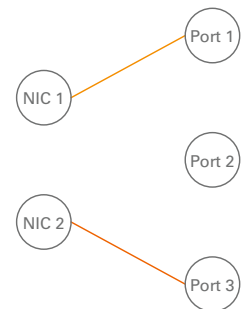
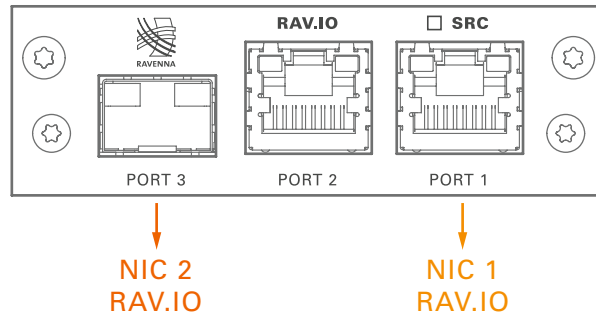

RAV.IO Audio & Control via Port 1 and Port 3

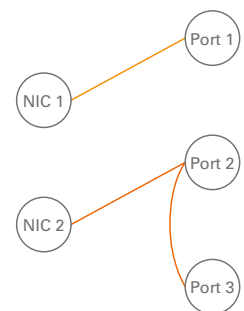
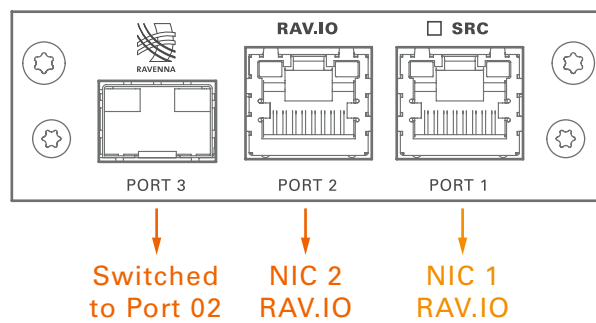

RAV.IO Audio & Control via Port 1 and Port 2
Extra ethernet traffic via Port 3 (NIC 2)

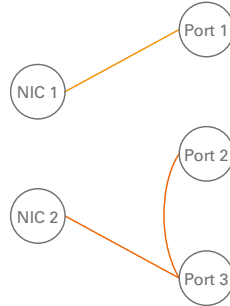
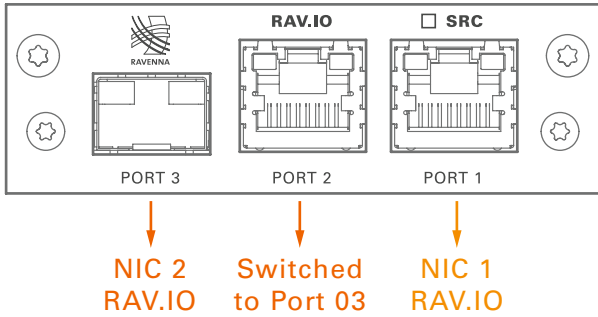

RAV.IO Audio & Control via Port 1 and Port 3
Extra ethernet traffic via Port 2 (NIC 2)

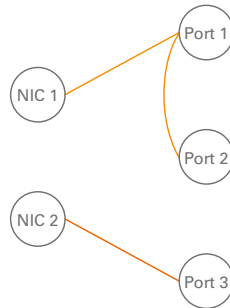
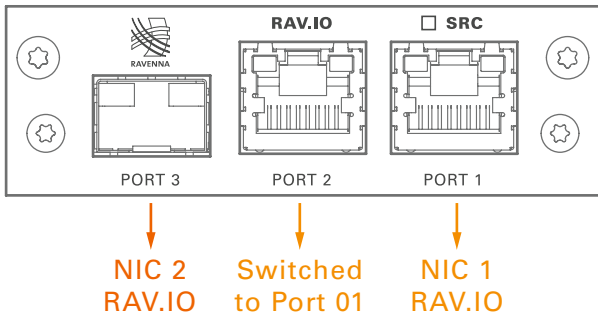

RAV.IO Audio & Control via Port 1 and Port 3
Extra ethernet traffic via Port 2 (NIC 1)*

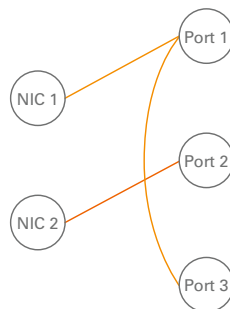
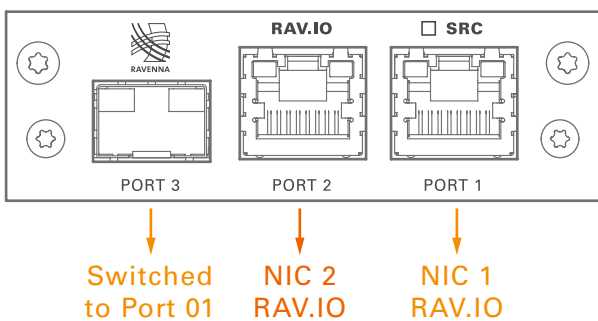

RAV.IO Audio & Control via Port 1 and Port 2
Extra ethernet traffic via Port 3 (NIC 1)

* see example on the following page.

Device Management over the audio network

This configuration is exemplary to illustrate the possibility to integrate the management data that is used to control the device into the audio network.

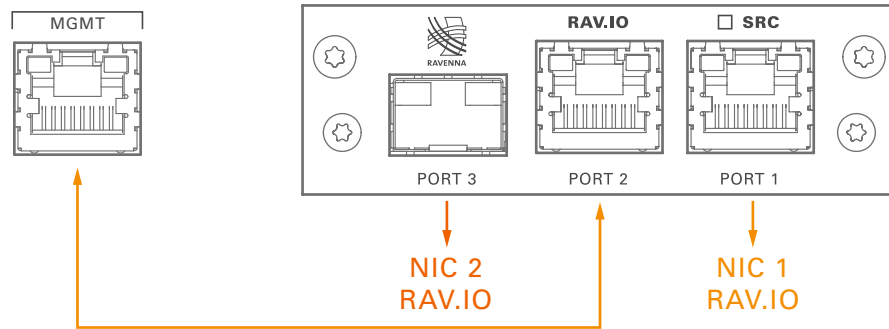

- connect the MGMT port of the device with Port 2 of the RAV.IO
- connect the RAVENNA network to Port 1 of the RAV.IO
- connect the RAVENNA network to Port 3 of the RAV.IO (if needed)

Switch configuration

RAV.IO Audio & Control via Port 1 and Port 3
Extra ethernet traffic via Port 2 (NIC 1)

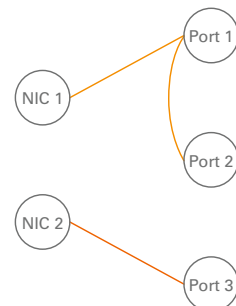

RAV.IO - Firmware Update

The RAV.IO module is updated via network.

Visit www.directout.eu and navigate to a PRODIGY product page.

Download:

- PRODIGY RAV.IO Firmware

Open the control page of the module and navigate to the tab STATUS and click SETTINGS in the top right corner (p 10).

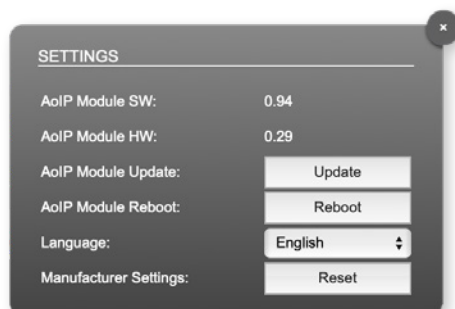

Click 'Update' and browse to the update file after unzipping first.

Example: rav_io_hw_0_29_sw_0_94.update

Follow the instructions displayed.

WARNING!



It is strongly recommended to backup the device configuration (Save Preset) before running any update.

Index

A		N	
AES67	23	Naming Input Stream.....	21
B		Network Monitor	42
BMCA	28	NMOS.....	36
D		O	
Direct routing.....	9	Offset	17
Discovery	19	Offset <> Packet time.....	16
F		P	
Firmware Update		Preset	11
RAV.IO	49	PTP Jitter	35
G		PTP Modes	28
GMID	8	PTP Profile	7
Grant duration.....	29	S	
H		Session Description Protocol.....	24
Hybrid Mode.....	27	Source Specific Multicast	21
I		ST 2110-30	23
IP Mode		Stream input	17
Hybrid	27	name	21
Multicast.....	27	Switch- Configuration	
Unicast	27	RAV.IO	46
IS-04. see NMOS		U	
IS-05. see NMOS		Unicast Mode	27
L		Unicast Stream	25
Logging.....	40		

This page is left blank intentionally.

DirectOut GmbH

Hainichener Str. 66a
09648 Mittweida
Germany

T: +49-3727-5650-00
M: info@directout.eu
www.directout.eu