

# EXBOX.MD

User's Manual



## Copyright

All rights reserved. Permission to reprint or electronically reproduce any document or graphic in whole or in part for any reason is expressly prohibited, unless prior written consent is obtained from the DirectOut GmbH.

All trademarks and registered trademarks belong to their respective owners. It cannot be guaranteed that all product names, products, trademarks, requisitions, regulations, guidelines, specifications and norms are free from trade mark rights of third parties.

All entries in this document have been thoroughly checked; however no guarantee for correctness can be given.

DirectOut GmbH cannot be held responsible for any misleading or incorrect information provided throughout this manual.

DirectOut GmbH reserves the right to change specifications at any time without notice.

DirectOut Technologies® is a registered trademark of the DirectOut GmbH.

© DirectOut GmbH, 2023

---

## Table of contents

<b>About This Manual</b>	<b>5</b>
How to Use This Manual	5
Conventions	5
<b>Chapter 1: Overview</b>	<b>6</b>
Introduction	6
Feature Summary	7
Applications	8
How it works	9
<b>CHAPTER 2: Legal issues &amp; facts</b>	<b>10</b>
Before Installing This Device	10
First Aid (in case of electric shock)	11
Defective Parts/Modules	12
Updates	12
Intended Operation	13
Conditions of Warranty	14
Conformity & Certificates	15
Contact	16
Contents	17
Accessories	18
<b>Chapter 3: Installation</b>	<b>21</b>
Installing the Device	21

<b>CHAPTER 4: Operation</b>	<b>27</b>
Introduction	27
Global Control	28
Input / Output - MADI	31
Input / Output - Network	32
Input State / Clocking	34
Sample Rate	40
State	42
<b>CHAPTER 5: Remote Control</b>	<b>44</b>
Dante Controller	44
EXBOX.MD Remote	53
<b>CHAPTER 6: Troubleshooting and Maintenance</b>	<b>73</b>
Troubleshooting	73
Maintenance	75
<b>CHAPTER 7: Technical Data</b>	<b>76</b>
<b>Appendix A - Wiring Sketches</b>	<b>79</b>
Hirose HR10 (DC PSU)	79
<b>Appendix B - Working with BLDS™</b>	<b>80</b>
Introduction	80
BLDS™ Generator	81
<b>Appendix C - Working with ch 57 mode</b>	<b>84</b>
<b>Appendix D - Firmware Update</b>	<b>85</b>
<b>Index</b>	<b>90</b>

## About This Manual

### How to Use This Manual

This manual guides you through the installation and operation of the device.

Use the Table of Contents at the beginning of the manual or Index Directory at the end of the document to locate help on a particular topic. You can access more information and latest news by visiting on the DirectOut website at [www.directout.eu](http://www.directout.eu).

### Conventions

The following symbols are used to draw your attention to:

#### **TIPS!**

---



indicate useful hints and shortcuts.

#### **NOTES!**

---



are used for important points of clarification or cross references.

#### **WARNINGS!**

---



alert you when an action should always be observed.

## Chapter 1: Overview

### Introduction

EXBOX.MD is an Audio-over-IP to MAD I converter based on Audinate’s audio networking technology Dante.



Equipped with three MAD I ports and four network ports it offers straight-forward conversion of 64 audio channels between MAD I and Dante.



Interfaces:

- 3 MAD I I/Os
- 4 Network ports (3 standard / 1 PoE)

The built-in network switch gives the opportunity to use Dante’s redundancy mode (Primary <> Secondary), while more EXBOX.MDs or other Dante devices can be connected in switched mode directly to increase the number of channels.

## Feature Summary

MADI Ports	1 x SC multi-mode connectors * 1 x SFP (empty cage without module) 1 x coaxial BNC connectors
Network	3 x RJ45 Socket (1 Gbit/s), 1 x RJ45 (1 Gbit/s, PoE)
Number of streams	32
Number of channels	64 @ 1 FS, 32 @ 2 FS, 16 @ 4 FS
Network Standards	Dante, AES67
Modes	Switched or Redundancy
Clock Sources	PTP, MADI, WCK, INT
Remote	Dante Controller, EXBOX.MD Remote, globcon control
MADI Formats	56/64 channel, 48k/96k Frame, S/MUX 2/4
Sample Rates	44.1, 48, 88.2, 96, 176.4, 192 kHz +/-12.5%
Signal Routing	Channel based routing matrix
Signal Processing	FastSRC™ at NET I/O (Dante)
Signal Redundancy	EARST™ (Enhanced Automatic Redundancy Switching)
Power Supply	external, 2 x Hirose connector (9-24 V) 1 x PoE (Power over Ethernet, IEEE 802.3af)

\* The SC I/O may be ordered as single-mode upon request.

## **Applications**

EXBOX.MD can be used as an easy to use frontend for bidirectional signal exchange between Dante and MADI environments.

Typical applications include:

- Integration of MADI in Dante setups
- Redundant recording setups using MADI and Dante Virtual Soundcard
- Mixing and monitoring using redundant Dante links between stage and FOH
- Signal switch for redundant playback setups



## How it works

Each MADI port and the Dante input can be selected as source for any output. A 'FastSRC™' can be enabled for seamless exchange of audio signals with the Dante network if the device is not clocked to the Dante network.

The network audio is controlled via the Dante Controller software provided by Audinate.

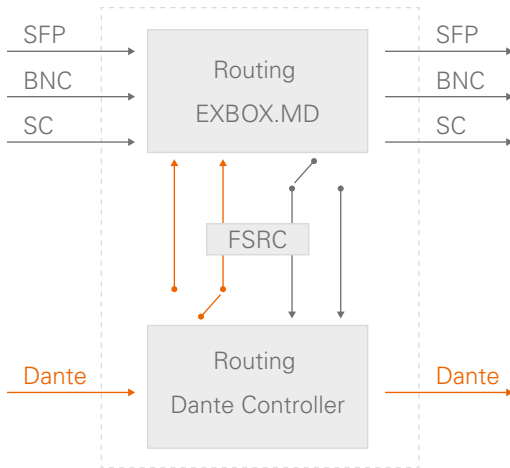

About FastSRC™ - see page 37.

## CHAPTER 2: Legal issues & facts

### Before Installing This Device



#### **WARNING!**

---

**Please read and observe all of the following notes before installing this product:**

- Check the hardware device for transport damage.
- Any devices showing signs of mechanical damage or damage from the spillage of liquids must not be connected to the mains supply, or disconnected from the mains immediately by pulling out the power lead.
- All devices must be grounded. The device is grounded through its IEC power connections.
- All devices must be connected to the mains using the three-cord power leads supplied with the system. Only supply electrical interfaces with the voltages and signals described in these instructions.
- Do not use the device at extreme temperatures. Proper operation can only be guaranteed between temperatures of 5° C and 45° C and a maximum relative humidity of 80 %, non-condensing.
- The cabinet of the device will heat up. Do not place the device close to heating sources (e.g. heaters). Observe the environmental conditions.

## First Aid (in case of electric shock)

### **WARNING!**

---



- Do not touch the person or his/her clothing before power is turned off, otherwise you risk sustaining an electric shock yourself.
- Separate the person as quickly as possible from the electric power source as follows:
  - Switch off the equipment.
  - Unplug or disconnect the mains cable.
- Move the person away from the power source by using dry insulating material (such as wood or plastic).
- If the person is unconscious:
  - Check their pulse and reanimate if their respiration is poor.
  - Lay the body down and turn it to one side. Call for a doctor immediately.
- Having sustained an electric shock, Always consult a doctor.



## Defective Parts/Modules

### **WARNING!**

---

This device contains no user-serviceable parts.

Therefore do not open the device.

In the event of a hardware defect, please send the device to your DirectOut representative together with a detailed description of the fault.

We would like to remind you to please check carefully whether the failure is caused by erroneous configuration, operation or connection before sending parts for repair.

## Updates

DirectOut products are continually in development, and therefore the information in this manual may be superseded by new releases. To access the latest documentation, please visit the DirectOut website: [www.directout.eu](http://www.directout.eu).

This guide refers to firmware version 1.7.5.

## Intended Operation

EXBOX.MD is designed for conversion / routing between network audio and MADI signals. MADI refers to AES10, network audio refers to Dante™ from Audinate.

## **WARNING!**

---



No compensation can be claimed for damages caused by operation of this unit other than for the intended use described above. Consecutive damages are also excluded explicitly. The general terms and conditions of business of DirectOut GmbH are applied.

## Conditions of Warranty

This unit has been designed and examined carefully by the manufacturer and complies with actual norms and directives.

Warranty is granted by DirectOut GmbH over the period of 36 months for all components that are essential for proper and intended operation of the device. The date of purchase is applied for this period. Consumable parts (e.g. battery) are excluded from warranty claims.



## **WARNING!**

---

All claims of warranty will expire once the device has been opened or modified, or if instructions and warnings were ignored.

For warranty claims please contact the dealer where your device was acquired.

## **Conformity & Certificates**

### **CE**

This device complies with the basic requests of applicable EU guidelines. The appropriate procedure for approval has been carried out.

### **RoHS**

(Restriction of the use of certain Hazardous Substances)

This device was constructed fulfilling the directive on the restriction of the use of certain hazardous substances in electrical and electronic equipment 2011/65/EU and 2015/863.

### **WEEE**

(Directive on Waste Electrical and Electronic Equipment)

Due to the directive 2002/96/EC for waste disposal this device must be recycled.

For correct recycling please dispatch the device to:

DirectOut GmbH,

Leipziger Str. 32

09648 Mittweida

Germany

Only stamped parcels will be accepted!

WEEE-Reg.-No. DE 64879540

## **Contact**

DirectOut GmbH

Leipziger Str. 32, 09648 Mittweida, Germany

Phone: +49 (0)3727 5665-100

Fax: +49 (0)3727 5665-101

Mail: [sales@directout.eu](mailto:sales@directout.eu)

[www.directout.eu](http://www.directout.eu)



## Contents

The contents of your EXBOX.MD package include:

- 1 x EXBOX.MD
- 1 x external power supply unit (9 - 24 V)
- 1 x Instruction Leaflet

To complete the delivery, download the Dante Controller software from Audinate's website.

Link: <https://www.audinate.com>

## Remote Control

The device can be managed either via web control in a browser or via globcon remote control.

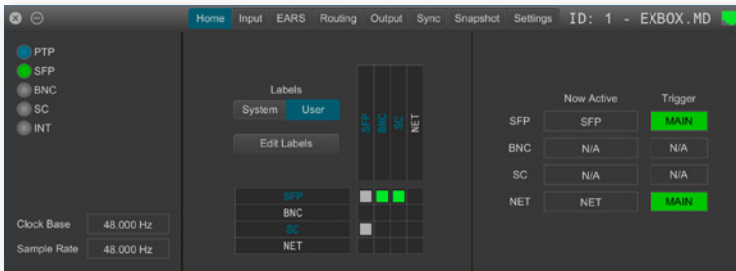

## globcon

globcon is a free, global control software platform for the management of professional audio equipment. Almost all products of the DirectOut product portfolio are supported by globcon.

Link: [www.globcon.pro](http://www.globcon.pro)

## Accessories

Two different optical SFP modules are available from DirectOut GmbH:

- Multimode SFP transceiver with LC connectors (No: DOICT0129)
- Singlemode SFP transceiver with LC connectors (No: DOICT0130)

### Specification of the optical SFP modules:

<b>SFP</b>	<b>Multimode</b>	<b>Singlemode</b>
Wavelength TX	1310 nm	1310 nm
Wavelength RX	1310 nm	1310 nm
Distance	2 km	10 km
Powerbudget (dB)	11 dB	12 dB
Protocols	Fast Ethernet OC3/ STM1	Gigabit Ethernet, Gigabit Fibre Channel
Bandwidth from	100 Mbit/s	1.050 Gbit/s
Bandwidth	155 Mbit/s	1.250 Gbit/s
Laser	FP	FP
Receiver Type	PIN	PIN
Connector	LC	LC

<b>SFP</b>	<b>Multimode</b>	<b>Singlemode</b>
Wavelength TX min	1260 nm	1260 nm
Wavelength TX max	1360 nm	1360 nm
Wavelength RX min	1260 nm	1260 nm
Wavelength RX max	1620 nm	1600 nm
Transmit min	- 19.00 dBm	- 9.00 dBm
Transmit max	- 14.00 dBm	- 3.00 dBm
Receive min	- 30 dBm	- 21.00 dBm
Receive max (Receiver overload)	- 5.00 dBm	- 3.00 dBm
Temperature (min)	0° Celsius	0° Celsius
Temperature (max)	70° Celsius	70° Celsius
Type of DDM/DOM	internal	internal
Extinction Ratio	8.20 dB	9 dB

BOX.MOUNT XL- for optimal rack mount of up to three devices in a 19" frame (No: DOAPA0886):



## Chapter 3: Installation

### Installing the Device

1. Open the packaging and check that the contents have been delivered complete and undamaged.
2. Place the device on a non-slip horizontal surface. The delivered pads may be affixed to the bottom of the cabinet. Ensure a clean and dry surface before affixing the pads.

### **WARNING!**

---



The synthetics of the delivered pads might cause stains on damageable surfaces. To avoid staining of furniture surfaces it is recommended to place a protective plate under the device.

### **WARNING!**

---



Avoid damage from condensation by waiting for the device to adapt to the environmental temperature. Proper operation can only be guaranteed between temperatures of 5° C and 45° C and a maximum relative humidity of 80%, non-condensing. Ensure that the unit has sufficient air circulation for cooling.

3. Remove the protective cap from the optical MADI port(s) before use.



## NOTE

Retain the protective cap if the optical port is unused. This will protect against soiling which can lead to malfunction.

4. Connect signal cable(s) for the MADI signals.



5. Plug in the network cable to the ethernet port(s) to connect the device with your computer.



## NOTE



Use appropriate network cables (CAT5E or better).

For larger setups an ethernet switch may become necessary. Recommended features for use with Dante:

- Managed Gigabit switch
- Quality of Service (QoS) with four queues
- Diffserv (DSCP) QoS, with strict priority

Information about network infrastructure:

<https://www.audinate.com/resources/networks-switches>

Dante FAQ:

<https://www.audinate.com/resources/faqs>

6. Using the power cord of the external power supply provided, connect the device to a matching power supply and connect the output of the power supply to the Hirose connectors at the rear panel.



This device may operate with only one power supply. To provide power supply redundancy, it is recommended to connect both PSU 1 and PSU 2 to independent power supplies with separate fuses.



## NOTE

The shipment includes one external power supply unit. Additional power supply units are available from your local DirectOut representative.



## WARNING!

The external power supply must be connected to the mains using the three-cord power leads supplied with the device. Only supply the voltages and signals indicated (9 - 24 V DC) to the device.



**WARNING!**

---



The connected power supply must provide a current limiting to a maximum of 2.5 A.



Power over Ethernet

The device can also be operated via a power over ethernet connection. Connect the port labelled '01 (PoE)' to an appropriate PoE switch (PoE Class 0 / 0.4 - 13W, IEEE 802.3af).

**WARNING!**

---



Never connect a PoE link to a network interface that is not marked explicitly for PoE operation. The voltage supplied there may damage the interface.

**TIP**

---



Keep any packaging in order to protect the device should it need to be dispatched for service.

This page is left blank intentionally.

## CHAPTER 4: Operation

### Introduction

This chapter describes the basic operation of the device.

Note that throughout this manual, the abbreviation FS refers to sample rate or sample frequency. So, when dealing with scaling factors, the following sample rates can be written as:

- 44.1 kHz or 48 kHz = 1 FS
- 88.2 kHz or 96 kHz = 2 FS
- 176.4 kHz or 192 kHz = 4 FS

## Global Control



PSU 1	<b>Hirose socket</b> Connect the power supply here (9- 24 V DC).
PSU 2	<b>Hirose socket</b> Connect the power supply here (9- 24 V DC).
01 (PoE)	<b>RJ45 socket</b> Connect PoE link here. PoE Class 0 / 0.4 - 13 W



### NOTE

The device does not provide a power switch. Connecting a working power supply to the device will power up the device immediately.



### WARNING!

Never connect a PoE link to a network interface that is not marked explicitly for PoE operation. The voltage supplied there may damage the interface.



POWER  
PSU 1  
PSU 2  
PoE

**LED green - indicates state of power supply**

○ (OFF) = power supply not working

● (ON) = power supply working

This page is left blank intentionally.

## Input / Output - MADI

Three different MADI ports enable flexible connectivity in various scenarios. Due to the device's routing capabilities format conversion between different MADI formats is possible.



MADI BNC OUT	<b>BNC socket</b> MADI output - connect here for MADI output signal.
MADI BNC IN	<b>BNC socket*</b> MADI or WCK input - connect MADI or word clock input signal here.
MADI SC OUT	<b>SC socket</b> MADI output - connect here for MADI output signal.
MADI SC IN	<b>SC socket</b> MADI input - connect MADI input signal here.
MADI SFP I/O	<b>SFP socket</b> Insert SFP module here and connect MADI input/output.

\* The BNC input may be operated as word clock input (AES11) - see page 57.

## Input / Output - Network

Four network ports are available for transmission of audio signals and remote control. The built-in network switch can be operated in three modes:

- switched - four ports, individual operation
- redundant - two ports, primary & secondary
- 1-3 primary, 4 secondary - three ports primary, one port secondary



The switch will be configured automatically by selecting the respective operation mode in Dante Controller.





With redundant operation each two interfaces (primary / secondary) are combined into a single logical port; i.e. port 1 / 2 and port 3 / 4.



### NOTE

If redundancy is being used, secondary interfaces should be connected to a second separate network. Secondary interfaces cannot communicate with primary interfaces.



01 (PoE)	<p><b>RJ45 socket (1 Gbit/s)</b> Network interface - connect here for network transmission. This port accepts a PoE source for power supply - see page 28.</p>
02	<p><b>RJ45 socket (1 Gbit/s)</b> Network interface - connect here for network transmission.</p>
03	<p><b>RJ45 socket (1 Gbit/s)</b> Network interface - connect here for network transmission.</p>
04	<p><b>RJ45 socket (1 Gbit/s)</b> Network interface - connect here for network transmission.</p>
LED left (Port 1 to 4)	<p><b>LED orange - indicates the link state of the network connection*.</b></p> <p> (ON) = device link active</p> <p> (OFF) = device link not active</p>
LED right (Port 1 to 4)	<p><b>LED green - indicates the activity state of the network connection.</b></p> <p> (ON) = data sent or received</p> <p> (OFF) = no data transmission</p>

\* Some possible reasons that lead to an inactive link:

- device switched off
- connected device switched off
- cabling issue

## Input State / Clocking

Five LEDs inform about the state of each signal input and the selected clock source of the device.

The device offers several options for clocking:

- PTP (Precision Time Protocol) - IEEE 1588-2002 / PTPv1 or v2 in AES67 mode
- MADI input
- Word Clock (@ MADI BNC input)\*
- internal clock generator



CLOCK SOURCE / SYNC SFP BNC* SC PTP INT	<b>LED - indicates selected clock source and the lock / sync state of MADI input, PTP-clock or the internal clock generator.</b>
	○ (OFF) = no signal lock
	● (50 % green) = signal lock, in sync
	● (100 % green) = signal lock, in sync, selected clock source
	● (blinking red) = signal lock, not in sync with selected clock source
	● (blinking green) = input selected as clock source and no signal lock.

\* See „Clocking to word clock“ on page 38.

The clock source of the device is adjusted via the remote control. Open the control page in a browser by entering the device's IP address.



The screenshot shows the Dante Controller software interface. The title bar reads 'Dante Controller - Network View'. The main window title is 'Grand Master Clock: EXBOX-MD'. The 'Clock Status' tab is selected, displaying a table with the following data:

Device Name	Sync	Mute	Clock Source	Domain Status	Primary v1 Multicast	Primary v2 Multicast	Secondary v1 Multicast	Secondary v2 Multicast	Prefer Mast	Enable Sync To External
EXBOX-MD	<input checked="" type="checkbox"/>	<input type="checkbox"/>	Dante	N/A	Master	Disabled	N/A	N/A	<input type="checkbox"/>	<input type="checkbox"/>
PRODIGY-14a99c	<input checked="" type="checkbox"/>	<input type="checkbox"/>	Dante	N/A	Slave	Disabled	N/A	N/A	<input type="checkbox"/>	<input type="checkbox"/>

PTP configuration is available in the tab 'Clock Status' of the software 'Dante Controller' from Audinate. PTP sync is handled by the Dante network automatically. EXBOX.MD can act as a PTP slave or Grandmaster (preferred master).

## Sync to External

When clocking to a source other than PTP, make sure to enable the 'Enable Sync to External' option for this device. The unit should also be 'preferred master' then to make sure that the Dante network is in sync with the system clock of EXBOX.MD.

Information about clocking in Dante network environments is available on the Audinate website: <https://www.audinate.com/resources/faqs>

### Sample Rate Conversion

Firmware 1.6 introduces optional sample rate conversion for the NET I/O (Dante). This is helpful if the device can't be clocked to the Dante network (or act as grandmaster).

The 'FastSRC™' (FSRC) is a low latency sample rate converter and ensures seamless exchange between MADI and Dante I/O when both sources are not synchronised. It is either switchable in the EXBOX Remote or in globcon.

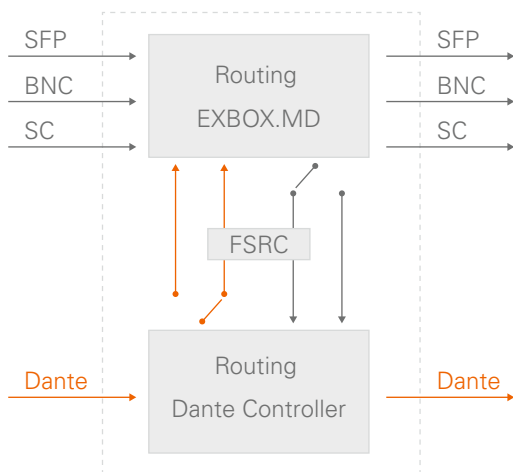

### NOTE

When the device is clocked via PTP, it is neither necessary nor recommended to activate the FSRC.

**NOTE**

---



With the FastSRC™ activated at the NET I/O (Dante) the trigger signal detection of EARST™ is limited to Pilot tone - see "EARST™- Triggering" on page 64.

**About FastSRC™**







DirectOut's FastSRC™ (FSRC) is a low latency sample rate converter for when two digital interfaces of a device must work in different clock domains.

FastSRC™ combines good sound quality with very low latency of less than 0.15 msec and is invaluable in live sound applications and a "life-saver" in critical situations.

High-end sample rate conversion requires noticeable processing time, so for the very best audio quality we recommend DirectOut's dedicated SRC products such as the RAV.SRC.IO, DANTE.SRC.IO, SG.SRC.IO or MAD12.SFP.IO.

### Clocking to word clock

The BNC MADI input also accepts a word clock signal according to AES11. The operating mode of the BNC input is selected in the MD Remote - see page 57.

<p>CLOCK SOURCE / SYNC BNC</p>	<p><b>LED - indicates selected clock source and the lock / sync state of MADI BNC / WCK input.</b></p> <ul style="list-style-type: none"> <li> (OFF) = no signal lock</li> <li> (50 % green) = signal lock, in sync</li> <li> (100 % green) = signal lock (MADI), in sync, selected clock source</li> <li> (100 % purple) = signal lock (WCK), in sync, selected clock source</li> <li> (blinking red) = signal lock, not in sync with selected clock source</li> <li> (blinking green) = input selected as clock source (MADI) and no signal lock.</li> <li> (blinking purple) = input selected as clock source (WCK) and no signal lock.</li> </ul>
--------------------------------	---

Independent from the operating mode of the MADI BNC input the MADI BNC output does output a MADI signal.

**TIP**



With the FastSRC™ activated you may clock the device to word clock and connect seamlessly to the Dante network.

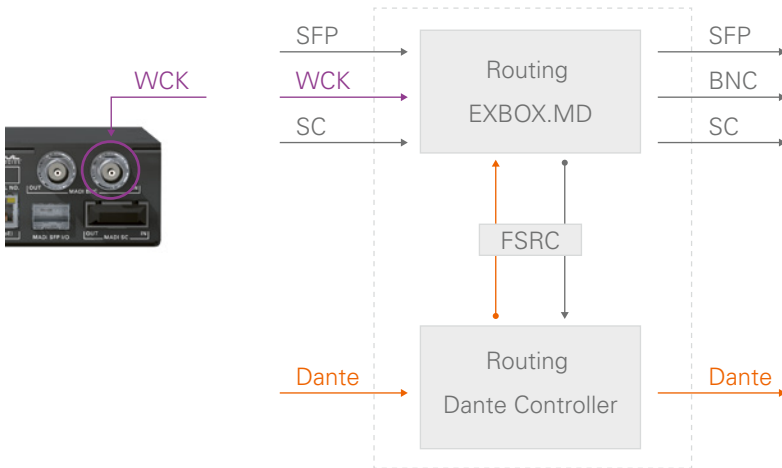

## Sample Rate

The base rate (44.1 kHz, 48 kHz) and the scaling factor (1 FS, 2 FS, 4 FS) is displayed by four leds at the front panel.



## NOTE

At higher sample rates the number of audio channels is reduced depending on the integer of the scaling factor:

- 64 channels at 1 FS
- 32 channels at 2 FS
- 16 channels at 4 FS



<p>SAMPLE RATE 44.1k</p>	<p><b>LED green - indicates the base rate of the audio engine.</b></p> <p><input type="radio"/> (OFF) = base rate is different from 44.1 kHz</p> <p><input checked="" type="radio"/> (ON) = base rate of 44.1 kHz (or multiple of) is used</p>
<p>SAMPLE RATE 48k</p>	<p><b>LED green - indicates the base rate of the audio engine.</b></p> <p><input type="radio"/> (OFF) = base rate is different from 48 kHz</p> <p><input checked="" type="radio"/> (ON) = base rate of 48 kHz (or multiple of) is used</p>
<p>SAMPLE RATE 2 FS</p>	<p><b>LED yellow - indicates the scaling factor of the base rate.</b></p> <p><input type="radio"/> (OFF) = scaling factor is 1 FS</p> <p><input checked="" type="radio"/> (ON) = scaling factor is 2 FS</p> <p><input type="radio"/> (blinking) = scaling factor does not match the sample rate of the brooklyn board.*</p>
<p>SAMPLE RATE 4 FS</p>	<p><b>LED white - indicates the scaling factor of the base rate.</b></p> <p><input type="radio"/> (OFF) = scaling factor is 1 FS</p> <p><input checked="" type="radio"/> (ON) = scaling factor is 4 FS</p>

\* At this time it is necessary to adjust the sample rate in both the Dante controller and the EXBOX.MD Remote when changing between 1 FS and 2 FS.

## State

The status of the Dante module is monitored by a LED at the front.



STATE	<p><b>LED - indicates the state of the Dante module.</b></p> <ul style="list-style-type: none"> <li>○ (OFF) = module not available</li> <li>● (ON) = module is working</li> <li>● (blinking) = module in failsafe mode*</li> <li>● (blinking) = firmware update running**</li> </ul>
-------	--

\* The Dante module starts into failsafe mode if its firmware is corrupted. This may happen in very rare cases only. Should you encounter this state, please contact support for further information.

\*\* After performing a firmware update a power cycle of the device will be necessary to program the device's internal flash. This process is indicated by a blinking rainbow pattern. It takes about 60 seconds and must not be interrupted. When finished all LEDs will go dark while the device is rebooting. To ensure proper operation another power cycle is recommended - see 'Firmware Update' on page 85.

This page is left blank intentionally.

## **CHAPTER 5: Remote Control**

### **Dante Controller**

To control a Dante network the application 'Dante Controller' needs to run on a computer that is connected to the network.

The software is available from the Audinate website (requires a free registration):

<https://www.audinate.com/products/software/dante-controller>

A detailed documentation about using Dante Controller is available here:

<https://dev.audinate.com/GA/dante-controller/userguide/webhelp/>

At startup Dante Controller scans the network for connected Dante devices and shows them automatically in the 'Network View'.

The IP address of a Dante device must fit into the network environment for proper operation of a Layer 3 based network. However Dante Controller will mark a device entry red if the IP Address is not matching the network environment and helps resolving the issue.

## NOTE

---



EXBOX.MD supports control via Dante Domain Manager.

When a device is enrolled in a domain, it can be viewed and configured in Dante Controller only by DDM users that are members of the domain.

To use an enrolled device outside of the domain it is required to un-enroll it from DDM first or to reset the device via Dante Controller.

User Guide 'Dante Domain Manager' (Chapter: Enrolling Devices in Domains)

<https://www.audinate.com/learning/technical-documentation>

## Network View

The 'Network View' is organised in several tabs. All detected Dante devices are shown on a list.

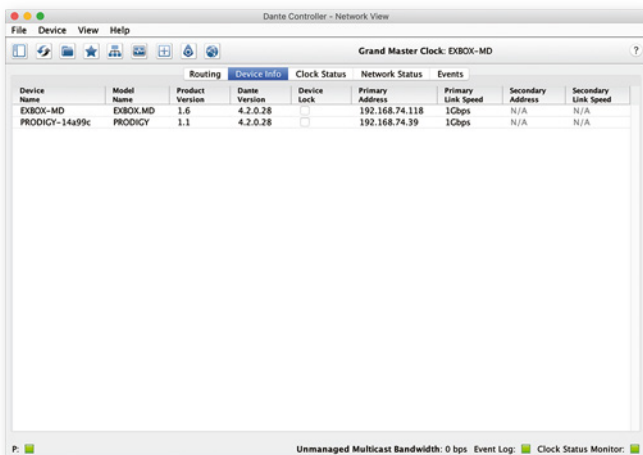

EXBOX.MD is delivered with the network interface set to DHCP as a default. Dante Controller can be used to discover the device on the network and change the IP configuration if necessary- see "Network Config" on page 50.

## Clock Status

The tab 'Clock Status' informs about the clock settings of each connected device and allows to modify them.

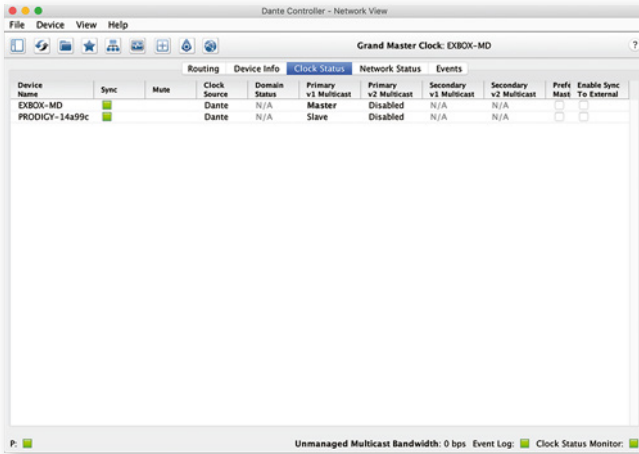

'Preferred Master' sets the device as PTP Grandmaster in the network

'Enable Sync to External' allows to clock the device from an external source (MADI input or internal). The device shall become Grandmaster of the network then.

## Routing

The audio signal routing is accessible in the tab 'Routing'

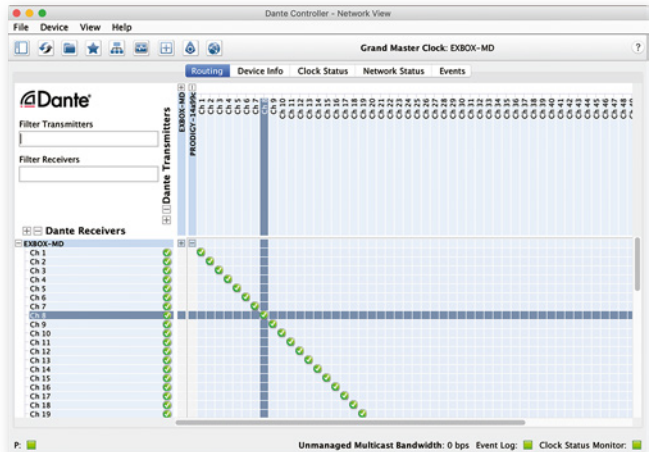

'Dante Receivers' in the vertical column displays the receiving devices (= destinations).

'Dante Transmitters' in the horizontal row displays the transmitting devices (= sources).

The channel list can be expanded or collapsed for each device.

Connections are made by clicking into the matrix.



## Device View

The 'Device View' is also organised in to several tabs. It can be opened by double-clicking on to a device name in the 'Network View'.

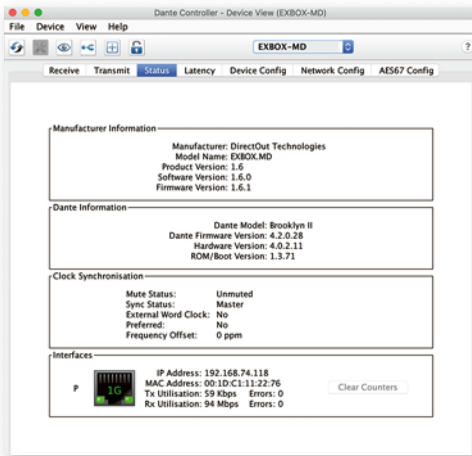

The status tab informs about the current firmware and software versions.

## TIP



To update your device the application you may either use the 'Dante Firmware Update Manager': <https://www.audinate.com/products/firmware-update-manager> or you update the device using the update function 'Dante Update' in the Dante Controller - see „Appendix D- Firmware Update“ on page 85.

## Network Config

The tab 'Network Config' of the device view provides access to the operating mode of the built-in network switch and the network settings of the device.

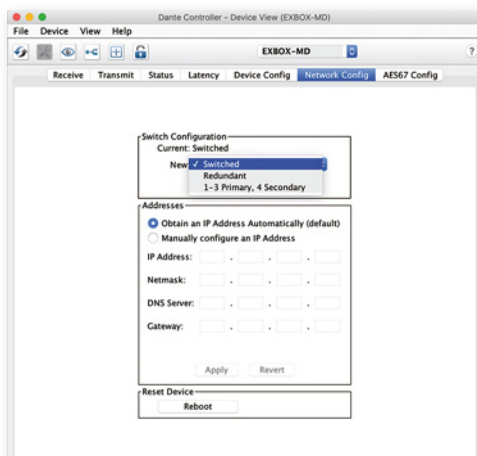

The switch offers three configuration options:

- switched - four ports, individual operation
- redundant - two ports, primary & secondary
- 1-3 primary, 4 secondary - three ports primary, one port secondary

See "Input / Output- Network" on page 32.

## Device Config

The tab 'Device Config' to adjust the device name, sample rate, encoding modes and more.

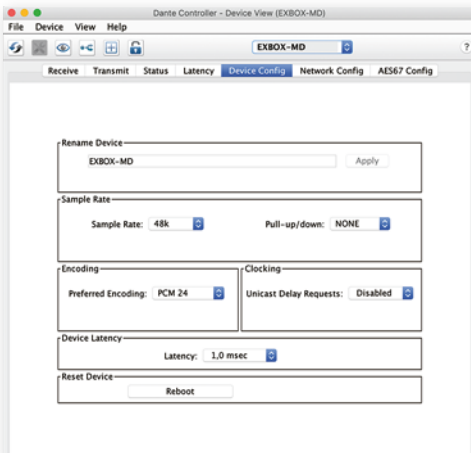

The clock source of the EXBOX.MD is configured in the web control of the EXBOX.MD.

Open a browser and enter the device's IP address to access the control page.

This page is left blank intentionally.

## EXBOX.MD Remote

Some device specific parameters are controlled via a website:

- Clock source
- Scaling factor of base sample rate
- FastSRC settings
- Audio signal routing
- EARS™ control
- DO.Net daemon control

The remote control is accessible via a browser. Enter the device's IP address to open the gui.

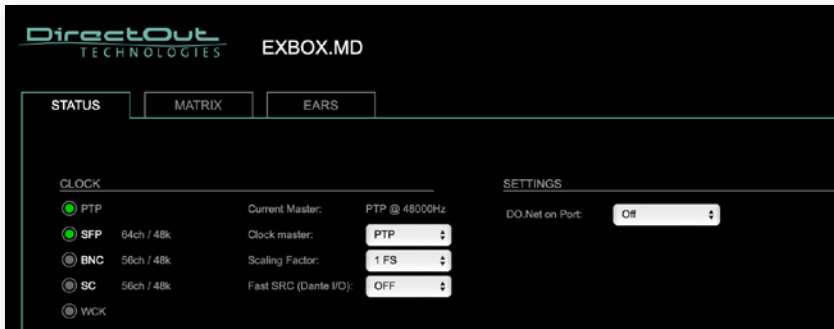

## STATUS - CLOCK

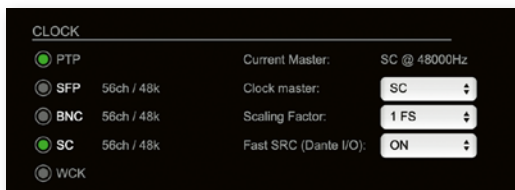

The LEDs inform about the lock / sync state of each MADi port and the PTP clock.

On the MADi input channel mode 56 / 57 and 64 channels are detected automatically.



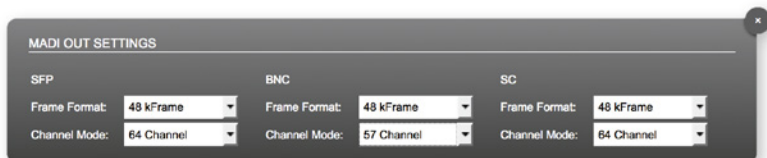



For the MADi output both frame format and channel mode can be set individually. Click on SFP or BNC or SC to open the settings.



Frame Format	Frame format for MADi output signal (48k / 96k Frame)*
Channel Mode	Channel mode for MADi output signal (56 ch / 57 ch / 64 ch)**

\* 96k Frame format is applied at 2 FS operation only.

\*\* See "Working with 57 ch mode" on page 84.

<p>SYNC PTP SFP BNC SC</p>	<p><b>LED - indicates selected clock source and the lock / sync state of MADI input, PTP-clock or the internal clock generator.</b></p> <p> (OFF) = no signal lock</p> <p> (100 % green) = signal lock, in sync, selected clock source</p> <p> (blinking red) = signal lock, not in sync with selected clock source</p> <p> (blinking green) = input selected as clock source and no signal lock.</p>
<p>SYNC WCK</p>	<p><b>LED - indicates selected clock source and the lock state of the WCK input.</b></p> <p> (OFF) = no signal lock</p> <p> (100 % purple) = signal lock selected clock source</p>

Current Master	Displays current clock master and measured sample frequency.
Clock master	<p><b>Pull-down menu - selection of clock source</b></p> <p>Values:</p> <p>PTP = PTP clock (Master or Slave)</p> <p>SFP = MADI SFP input</p> <p>BNC = MADI BNC input</p> <p>SC = MADI SC input</p> <p>INT 44.1 = internal clock generator 44.1 kHz</p> <p>INT 48 = internal clock generator 48 kHz</p> <p>WCK* = Word Clock @ MADI BNC input</p>
Scaling Factor	<p><b>Pull-down menu - selection of scaling factor of base sample rate</b></p> <p>Values: 1 FS, 2 FS, 4 FS **</p>
Fast SRC™	<p><b>Pull-down menu - enabling / disabling of Sample Rate Conversion at NET I/O ***</b></p> <p>OFF = SRC not active</p> <p>ON = SRC active</p>

- \* Selecting WCK as clock source will change the operating mode of the MADI BNC input, accepting a word clock signal according to AES11 there.
- \*\* See „Introduction“ on page 27.
- \*\*\* See „Sample Rate Conversion“ on page 36.



## Clocking to word clock

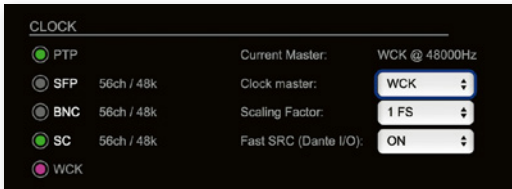

- MADI BNC input expects a word clock signal (AES11)
- BNC input in the routing matrix can still be patched as source, but will not transmit audio.
- EARS™ mode 'Dante > BNC' will not work as expected, as the BNC input is not available as backup source.
- DO.NET on port BNC will not work.
- Check 'Enable Sync to External' in the Dante Controller - see page 35.

### STATUS - SETTINGS - DO.NET

To enable remote control via network a so-called DO.Net daemon is used to transmit the control data between the ethernet connection of the EXBOX.MD and one selected MADI port.

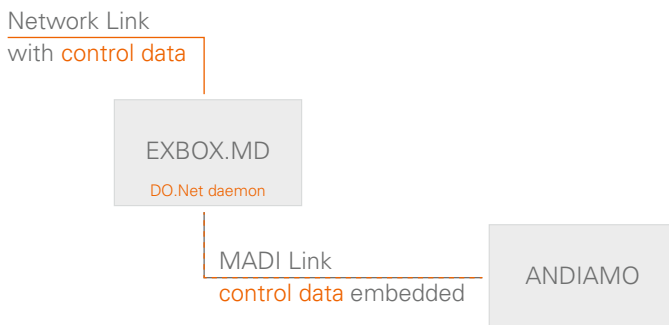

DO.Net can be used to remote control any ANDIAMO converter via network using the MADI link between EXBOX.MD and the ANDIAMO.



### NOTE

The MADI link must be bidirectional and no 3rd party devices shall be used in the signal chain. Clocking to word clock will interrupt the transmission of the control data when the MADI BNC port is selected for DO.Net.



DO.Net  
on Port

**Pull-down menu to select the MADI port for remote control.**

Values:

- Off = no control data de-/embedded
- SFP = control data at SFP port
- BNC = control data at BNC port
- SC = control data at SC port

## NOTE



### Large Network Environments

For proper transport of the control data via network check to enable UDP Multicast Routing in the entire network for 224.7.7.7 Ports 7777 to 8555. IGMP v3 is used.

If you experience trouble connecting the device with the remote, you may start with a point-to-point setup first.

### **EARS™ - Overview**

EARS™ (Enhanced Automatic Redundancy Switching) is a system to prevent interruption of the output signal. It uses either the proven BLDS™ technology or pilot tone triggering. A logic monitors the condition of the trigger signal on the input. In case of a failure it switches automatically to the backup input.

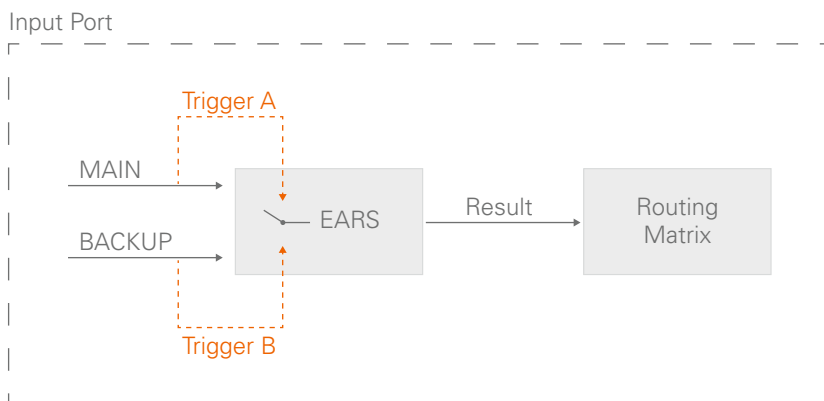

### **NOTE**

Firmware 1.7 introduced EARS for all four ports (BNC, SC, SFP, NET) and with full routing support available. The result of the logic is used as signal source in the routing matrix.

Ports defined as BACKUP can also be used independent from EARS for further signal routing.

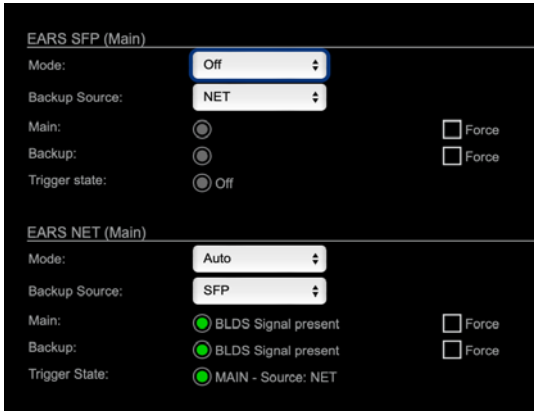

EARS is available for all four I/O ports of the device (BNC, SC, SFP, NET)

The signal source for BACKUP can be selected (Backup Source - page 62).

The signal status of the trigger signal and the switching result (Trigger State - page 65) is displayed by leds.

MAIN or BACKUP can be prioritized or set to 'Auto' (Modes - page 63).

To override automatic switching temporarily the source can be forced to MAIN or BACKUP (Force- page 66).

### EARS™ - Backup Source

For each I/O port a backup source is selected via a pull-down menu.

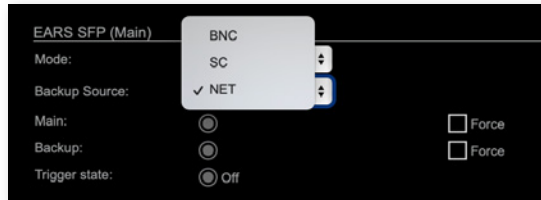

The NET port (Dante) offers an additional mode where:

- MAIN is sourced by NET channel 1 to 32
- BACKUP is sourced by NET channel 33 to 64

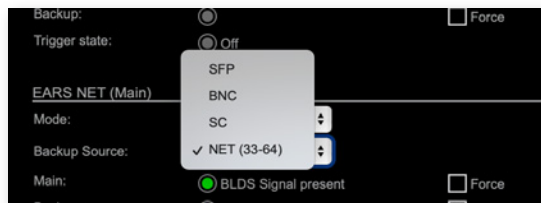

Trigger signals are expected at the 'last audio channel' of signal source - see page 64.

### EARS™ - Modes

EARS can be activated for each I/O port individually. Activation and the priority behavior is adjusted via a pull-down menu.



OFF	EARS is not active
Prio Main	EARS is active, MAIN is prioritized*
Prio Backup	EARS is active, BACKUP is prioritized*
Auto	EARS is active, automatic port selection, switch-over when required, no revert

\* trigger signal must be identical, BLDS™ has priority over pilot tone.

Example: Prio MAIN, but BACKUP selected



### **EARS™ - Triggering**

EARS supports two kinds of trigger signals:

- BLDS™ (generated by the BLDS™ Generator)
- Pilot tone (audio signal with a level higher than -40 dBFS).

Switching by BLDS™ trigger is immediate (between two samples). The Pilot tone is evaluated for 10ms before switching is triggered.

Trigger signals are expected at the 'last audio channel' of signal source:

Trigger expected	1 FS	2 FS	4 FS
BNC / SC / SFP / NET*	ch 64	ch 32	ch 16
NET (33-64)**	ch 32 / 64	ch 16 / 32	ch 8 / 16

\* ch 56 / 28 / 14 using MADi channel mode 56 ch

\*\* available only for NET



### **NOTE**

With the FastSRC™ activated at the NET I/O (Dante) the trigger signal detection of EARS™ is limited to Pilot tone.

See "Sample Rate Conversion" on page 36.





























### Trigger State / Priorities

BLDSTM™ has priority over pilot tone:

'BLDSTM™' > 'Pilot tone' > 'no trigger'

Switching result table

Main	Backup	Output
 BLDSTM™	 BLDSTM™	 Main
 BLDSTM™	 pilote tone	 Main
 BLDSTM™	 no trigger	 Main
 pilote tone	 BLDSTM™	 Backup
 pilote tone	 pilote tone	 Main
 pilote tone	 no trigger	 Main
 no trigger	 BLDSTM™	 Backup
 no trigger	 pilot tone	 Backup
 no trigger	 no trigger	 Main

The priority setting ("Modes" on page 63) effects only when the trigger signals at both sources are identical (e.g. both BLDS).

### **EARS™ - Force**

To override automatic switching temporarily, the source for the output can be forced to MAIN or BACKUP.

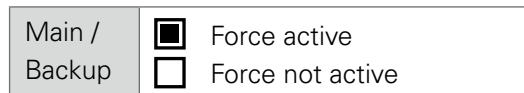
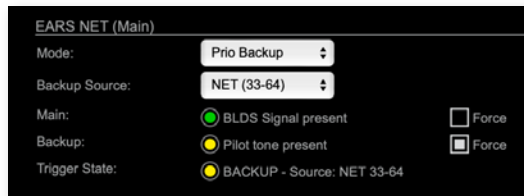

### **TIP**

---

Force Mode can be helpful to stay with one system as a source while testing the second one.

## EARS™ - Status Display

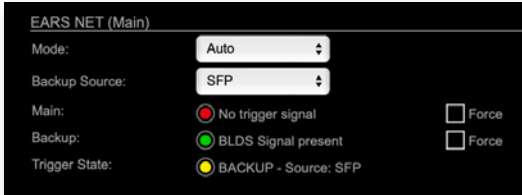

Main	<p><b>LED indicates state of trigger signal in audio channel 64 (or channel 32*)</b></p> <ul style="list-style-type: none"> <li> (OFF) = no trigger expected</li> <li> (100 % green) = BLDS™ signal present</li> <li> (100 % yellow) = Pilot tone present</li> <li> (blinking red) = no trigger signal</li> </ul>
Backup	<p><b>LED indicates state of trigger signal in audio channel 64.</b></p> <ul style="list-style-type: none"> <li> (OFF) = no trigger expected</li> <li> (100 % green) = BLDS™ signal present</li> <li> (100 % yellow) = Pilot tone present</li> <li> (blinking red) = no trigger signal</li> </ul>
Trigger state	<p><b>LED indicates switching result of logic</b></p> <ul style="list-style-type: none"> <li> (OFF) = standard routing active</li> <li> (100 % green) = both or no trigger signals detected, MAIN input active</li> <li> (100 % yellow) = Backup trigger active, BACKUP input active</li> </ul>

\* NET divided in to 32 + 32 channels - see page 62.

This page is left blank intentionally.

## STATUS - DEVICE

Information about the current PSU state, the device's firmware and software version and the serial number.



This information is required when contacting DirectOut Support.

## PSU State

Three LEDs inform about the current state of each PSU individually.

PSU 1, PSU 2, PoE	<p><b>LED indicates state of power supply (PSU).</b></p> <p><input type="radio"/> (OFF) = psu not active</p> <p><input checked="" type="radio"/> (100 % green) = psu active</p> <p><input type="radio"/> (blinking yellow) = psu active, after failure</p> <p><input type="radio"/> (blinking red) = psu not active, after being active before</p>
-------------------------	--

To reset the display of the PSU state click on one of the LEDs.

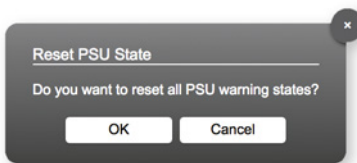

## MATRIX

The tab 'MATRIX' manages 192 MADI channels (SFP, BNC, SC) and 64 network channels (Dante) and the BLDS generator.

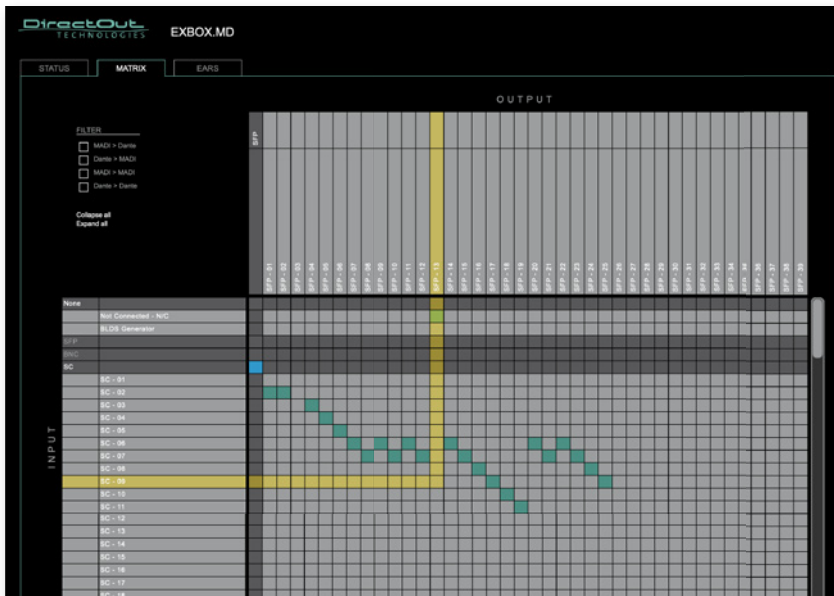

## Organisation

- Inputs - vertical column
- Outputs - horizontal row
- Click on SFP, BNC, SC or Dante to expand or collapse the corresponding i/o.

## Filter

Viewing filters can be applied to focus on used areas for patching.

MADI > Dante	MADI inputs and Dante outputs
Dante > MADI	Dante inputs and MADI outputs
MADI > MADI	MADI inputs and MADI outputs
Dante > Dante	NET inputs and NET outputs
Collapse all	all i/os collapsed
Expand all	all i/os expanded

## Patching

- A yellow crossline marks the hotspot for setting a patch.
- Patches are marked by a green square.
- To set a patch  
Move the hotspot to the desired position + Click
- To delete a patch  
Move the hotspot up to  
,Not Connected- NC' + Click  
or  
ALT + Click the current patch
- Multi-channel patches (diagonal and horizontal):  
SHIFT + Click start + Click end
- Multi-channel patches to N/C  
ALT + SHIFT + Click start + Click end
- The blue square allows for quick 1:1 patches per port using CTRL + Click and CTRL + ALT + Click to set all outputs to 'not connected'.

This page is left blank intentionally.



## CHAPTER 6: Troubleshooting and Maintenance

### Troubleshooting

To identify a possible defect with the device please consult the following table.

If the fault cannot be resolved using these instructions, please contact your local DirectOut representative or visit [support.directout.eu](http://support.directout.eu).

<b>Issue</b>	<b>Possible reason</b>	<b>Solution</b>
Device doesn't work.	Power supply is broken.	Check that the power supply switch is on, that the device is connected to the power supply and that the socket is working. Defective fuses must be exchanged by qualified service personal only.
Optical port does not work.	Optic is dirty.	Use an air supply to carefully remove any dust. Never use objects for cleaning.
No signal at the output port.	Connections (input / output) are mixed up.	Check the connections and change the cables if necessary. Check the routing matrix.

<b>Issue</b>	<b>Possible reason</b>	<b>Solution</b>
No signal at the output port.	Signal cable defective.	Exchange the signal cable.
No signal at the output port.	Connectors of the signal cable are dirty.	Use an air supply to carefully remove any dust. Never use objects for cleaning. or Exchange the signal cable.
MADI signal at the input is not stable.	Signal source is defective or bad signal condition (Jitter > 1 ns)- e.g. due to exceeded length or bad screening attenuation of signal cable.	Change the source or use appropriate cables.
LED PTP blinking red	NET I/O (Dante) not in sync with the device's clock source	Sync to PTP or Enable FastSRC™

## Maintenance

To clean the device, use a soft, dry cloth. To protect the surface, avoid using cleaning agents.

### NOTE

---



The device should be disconnected from the power supply during the cleaning process.

## CHAPTER 7: Technical Data

### Dimensions

- Width 140 mm
- Height 42 mm
- Depth 146 mm

### Weight

- 0.7 kg

### Power Consumption

- 9 W (typical)

### Power Supply

- 2 x Hirose socket (HR10)
- 9 V- 24 V DC (external)



## WARNING

---

The connected power supply must provide a current limiting to a maximum of 2.5 A.

### Environmental Conditions

- Operating temperature +5°C up to +45°C
- Relative humidity: 10% - 80%, non condensing

### **MADI Ports SC optical**

- SC socket FDDI (input / output)
- ISO/IEC 9314-3
- Wave length 1310 nm
- Multi-Mode 62.5/125 or 50/125

### **MADI Ports BNC coaxial**

- BNC socket (input / output)
- Impedance: 75  $\Omega$
- 0.3 V up to 0.6 V (peak to peak)

### **MADI Ports SFP**

- empty cage without module

### **Sample Rate**

- 30 - 50 kHz @ 1 FS
- 60 - 100 kHz @ 2 FS
- 120 - 200 kHz @ 4 FS

### **MADI Format (I/O)**

- 48k Frame, 96k Frame
- 56 channel, 64 channel

### **Network**

- 4 x RJ45 socket
- Gigabit Ethernet
- for transmission of network audio, control data and firmware updates
- Network-Layer 3
- 32 streams
- 64 channels I/O @ 1 FS (32@2FS, 16@4FS)
- Standard: Dante, AES67
- Brooklyn II or 3 module, Firmware 4.x

### **PoE (Network Port 1)**

- PoE Class 0 / 0.4 - 13W
- IEEE 802.3af

### **Sample Rate Conversion**

- FastSRC™ @ NET I/O (Dante)
- Latency: less than 0.15 ms @ all scaling factors

## Appendix A - Wiring Sketches

### Hirose HR10 (DC PSU)

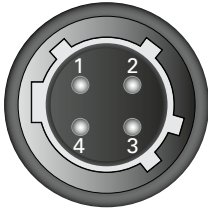

Pin	Signal
1	DC +
2	DC +
3	DC -
4	DC -

#### NOTE

To ensure proper operation all pins should be connected.



#### NOTE

Ground is connected with the chassis of the plug (safety class 1).



## Appendix B - Working with BLDS™

### Introduction

The Buffer Loop Detection System™ is used to detect silence or a corrupted input signal- e.g. caused by an application hang of the playout system (repeating buffers) or stuttered playback due to system overload.

A BLDS™ generator creates a .wav file containing a low levelled signal which is inserted into the MADI stream. The artificial design of the BLDS™ signal enables reliable and inaudible switch-over within one sample.



### NOTE

Firmware 1.7 introduced a BLDS generator available in the MATRIX. The generator output can be routed to any output channel.





## BLDS™ Generator

The application is available for Windows® and macOS®.

1. Download the application at [www.directout.eu](http://www.directout.eu)
2. Unpack the zip archive and open the 'BLDS™\_Generator.exe' (Windows®) or 'BLDS™ Generator.app' (macOS®).

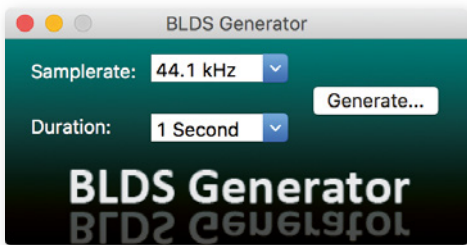

3. Define sample rate and duration using the drop down menus.

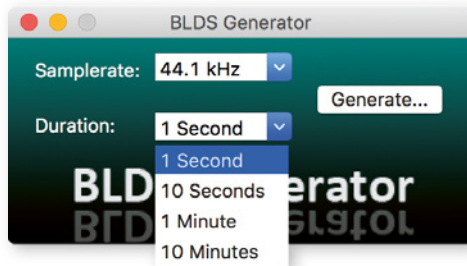
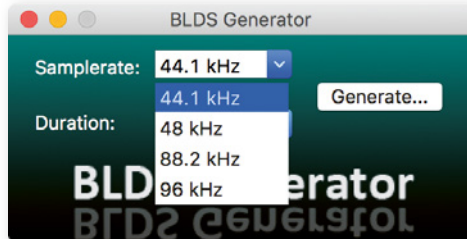

4. Click 'Generate' to save the a 24 bit mono .wav file with the settings specified.



## NOTE

---

The BLDS™ signal is designed so that it is 16 bit safe and the level is below -60 dBFS.

5. A 'Save as' dialogue appears. Store the file to your preferred location.

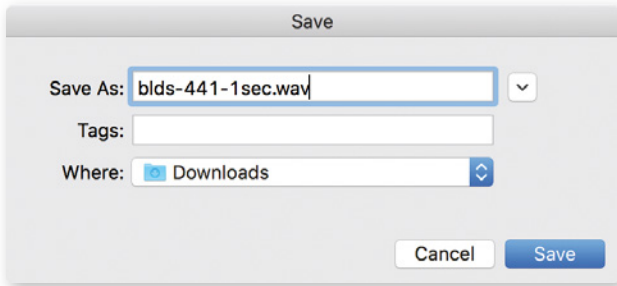

6. Import the .wav file into an audio session of your DAW. The BLDS™ signal needs to be present in the audio channel that is monitored by the triggered switch.

## NOTE

---



When duplicating the signal in the timeline carefully check that there are no gaps, crossfades or overlaps at the boundaries. This violates the BLDS™ condition resulting in possibly unwanted behaviour.

## Appendix C - Working with ch 57 mode

Channel mode 57 ch on the MADi output enables transparent pass-through of embedded control data that is used by DiGiCo consoles.

Ch 57 mode is detected at the MADi input automatically and signaled to the user.

To preserve the control data throughout the signal chain:

- set MADi output to 57 ch mode
- route input channel 57 to output channel 57

The control data is preserved also across a Dante connection to another EXBOX.MD, where it is output to MADi.



### NOTE

---

The incoming control data is neither examined nor altered by the EXBOX.MD.

## Appendix D - Firmware Update

The device can be updated using the 'Dante Updater' which is integrated in the latest version of the 'Dante Controller'.

### **WARNING**

---



It is strongly recommended to backup the device configuration before running any update.

### **WARNING**

---



It is strongly recommended to use the latest version of 'Dante Controller' to perform the update.

1. Open Dante Controller
2. Menu: View- Dante Updater (CMD-U)
3. Select device to update and click 'Update Selected Devices'

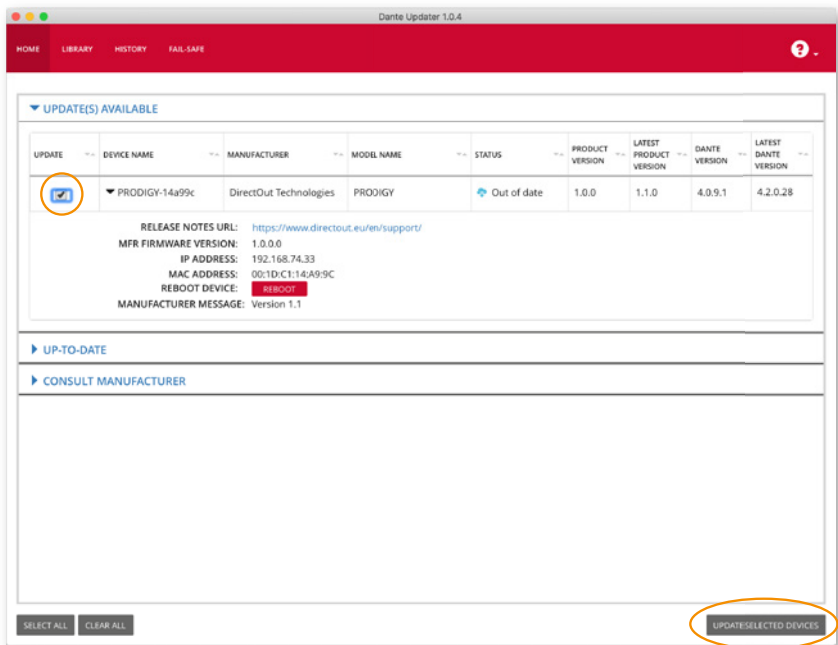

4. Confirm and take your time until the update procedure has finished.

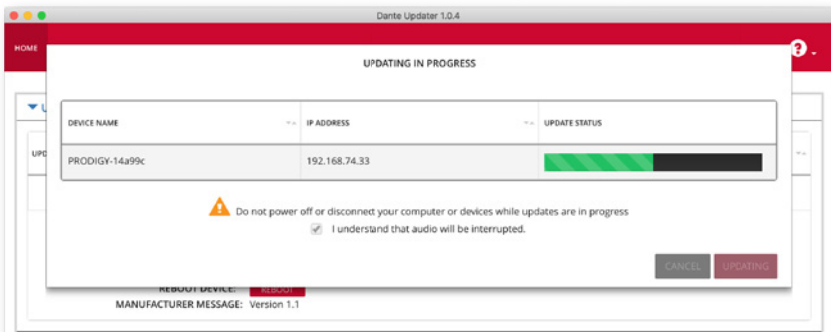
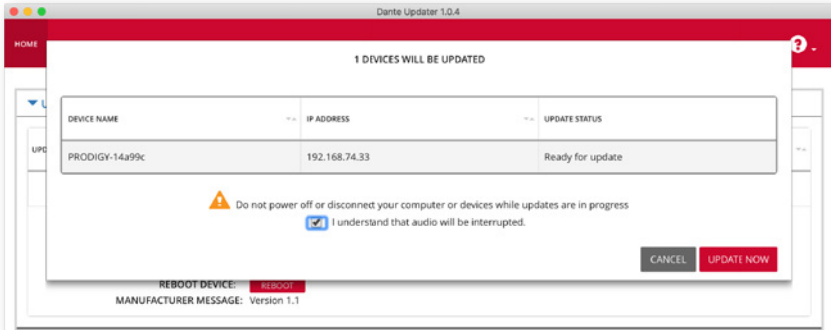

5. Mark the updated device for reboot and click 'Reboot Selected Devices'.

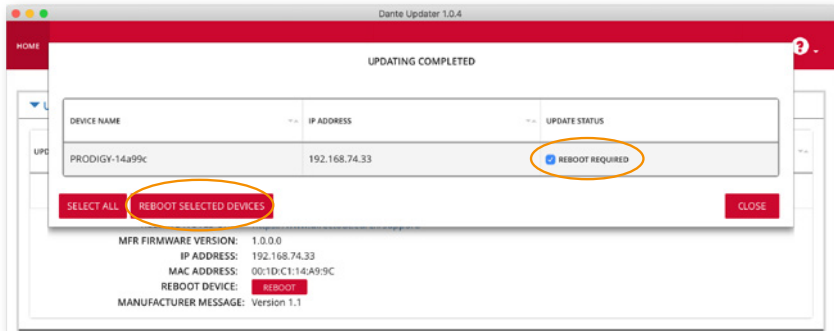

6. After Reboot the Updater will report the Update Status.

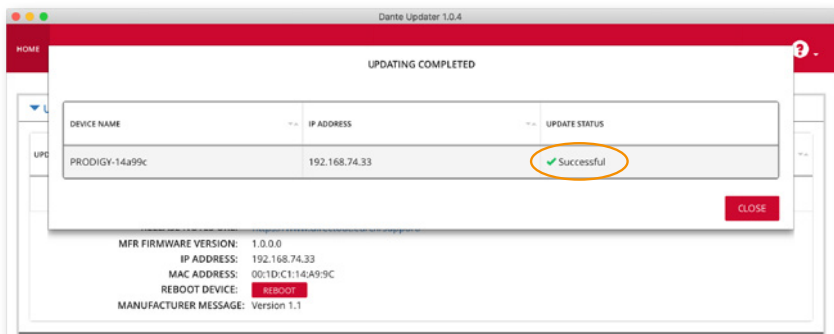



This page is left blank intentionally.

## Index

### A

Accessory ..... 18

### B

BLDST™ ..... 64

    generating ..... 81

BOX.MOUNT XL..... 20

Brooklyn module..... 78

### C

Channel Mode 57 ch ..... 84

#### Clocking

    FAQ..... 35

    Options..... 34

    Preferred master..... 35

    Sync to External..... 35

    Word Clock..... 38, 57

#### Conformity & Certificates

    CE..... 15

    RoHS ..... 15

    WEEE ..... 15

Contact ..... 16

Contents ..... 17

Conventions..... 5

### D

Dante Domain Manager .... 45

Dante module state ..... 42

Defective Parts/Modules .... 12

DigiCo..... 84

Dimensions..... 76

DO.Net..... 58

### E

EARST™ ..... 60

Environmental conditions 21, 76

Ethernet switch ..... 23

### F

FastSRC™..... 37

Firmware ..... 49

Firmware Update..... 85

First Aid ..... 11

Force (EARS)..... 66

### G

globcon control..... 17

### I

Intended Operation..... 13

### M

MADI formats..... 7

**P**

Patching.....	71
Pilot tone .....	64
PoE Class.....	78
Power supply .....	7
Primary / secondary .....	32
PSU Reset .....	69
PSU State .....	69

**R**

Remote Control	
Dante Controller .....	44
EXBOX.MD Remote .....	53

**S**

Sample Rate Conversion ...	36
FastSRC™ .....	37
Sample rates.....	7
Scaling Factor .....	27
SFP Modules .....	18
Sketch	
Hirose HR10 (DC PSU) ..	79
Support.....	73

**T**

Technical data .....	76
Trigger signals.....	64
Troubleshooting .....	73

**U**

Updates .....	12
---------------	----

**W**

Warranty .....	14
----------------	----





**DirectOut GmbH**

Leipziger Strasse 32  
09648 Mittweida  
Germany

T: +49-3727-5665-100  
F: +49-3727-5665-101  
[www.directout.eu](http://www.directout.eu)