

EXBOX.SG

User's Manual



Copyright

All rights reserved. Permission to reprint or electronically reproduce any document or graphic in whole or in part for any reason is expressly prohibited, unless prior written consent is obtained from the DirectOut GmbH.

All trademarks and registered trademarks belong to their respective owners. It cannot be guaranteed that all product names, products, trademarks, requisitions, regulations, guidelines, specifications and norms are free from trade mark rights of third parties.

All entries in this document have been thoroughly checked; however no guarantee for correctness can be given.

DirectOut GmbH cannot be held responsible for any misleading or incorrect information provided throughout this manual.

DirectOut GmbH reserves the right to change specifications at any time without notice.

DirectOut Technologies® is a registered trademark of the DirectOut GmbH.

© DirectOut GmbH, 2021

Table of contents

About This Manual	5
How to Use This Manual.....	5
Conventions	5
Chapter 1: Overview	6
Introduction	6
Applications.....	6
Feature Summary.....	7
How it works.....	7
CHAPTER 2: Legal issues & facts	8
Before Installing This Device.....	8
Defective Parts/Modules	8
First Aid (in case of electric shock).....	9
Updates.....	10
Conditions of Warranty	10
Intended Operation	10
Conformity & Certificates	11
Contact.....	11
Contents	12
Accessory.....	13
Chapter 3: Installation	15
Installing the Device	15
CHAPTER 4: Operation	23
Introduction	23
Global Control.....	24
Input / Output - MADI	25
Input / Output - Network.....	26
Input State / Clocking	27
Sample Rate	30
State.....	31

CHAPTER 5: Controlling	32
Soundgrid - Host	32
Soundgrid - EXBOX.SG Control.....	35
globcon - EXBOX.SG plugin	38
CHAPTER 6: Troubleshooting and Maintenance	42
Troubleshooting.....	42
Maintenance.....	43
CHAPTER 7: Technical Data	44
Appendix A - Wiring Sketches	46
Hirose HR10 (DC PSU)	46
Appendix B - Working with ch 57 mode	47
Appendix C - Firmware Update	48
Appendix D: Application Examples	50
Example 1 - Soundgrid < > MADI.....	50
Example 2 - Mixing with Plugin Server	50
Example 3 - Mixing with Plugin Server	51
Index	52

About This Manual

How to Use This Manual

This manual guides you through the installation and operation of the device. Use the Table of Contents at the beginning of the manual or Index Directory at the end of the document to locate help on a particular topic. You can access more information and latest news by visiting on the DirectOut website at www.directout.eu.

Conventions

The following symbols are used to draw your attention to:

TIPS

indicate useful hints and shortcuts.



NOTES

are used for important points of clarification or cross references.



WARNINGS!

alert you when an action should always be observed.



Chapter 1: Overview

Introduction

EXBOX.SG is an audio network to MADi converter based on the audio networking technology Soundgrid from Waves.



Equipped with three MADi ports and four network ports, it offers straight-forward conversion of 128 audio channels between MADi and Soundgrid.



Four network ports are connected to an internal switch and give the opportunity to connect several devices without the need of an additional switch.

Applications

EXBOX.SG can be used as an easy to use frontend for bidirectional signal exchange between Soundgrid and MADi environments.

Typical applications include:

- Integration of MADi in Soundgrid setups
- Plugin Server Integration
- Live Sound

Feature Summary

MADI Ports	1 x SC multi-mode connectors * 1 x SFP (empty cage without module) 1 x coaxial BNC connectors
Network	3 x RJ45 Socket (1 Gbit/s), 1 x RJ45 (1 Gbit/s, PoE)
Number of channels	128 @ 1 FS, 64 @ 2 FS
Network Standards	Soundgrid
Clock Sources	Sync over Ethernet (SoE), MADI, WCK, INT
Remote	globcon control via MIDI tunnel Soundgrid application (e.g. SG Studio, SG QRec)
MADI Formats	56/57/64 channel, 48k/96k Frame, S/MUX 2/4
Sample Rates	44.1, 48, 88.2, 96 kHz +/-12.5%
Signal Routing	Port based routing matrix
Power Supply	external, 2 x Hirose connector (9-24 V) 1 x PoE (Power over Ethernet, IEEE 802.3af)

* The SC I/O may be ordered as single-mode upon request.

How it works

Each MADI port and the Soundgrid input can be selected as source for any output. Device functions such as signal routing, MADI output format and clock settings are controlled via globcon.

The audio network is controlled via a Soundgrid host application (e.g. SG Studio or SG QRec).

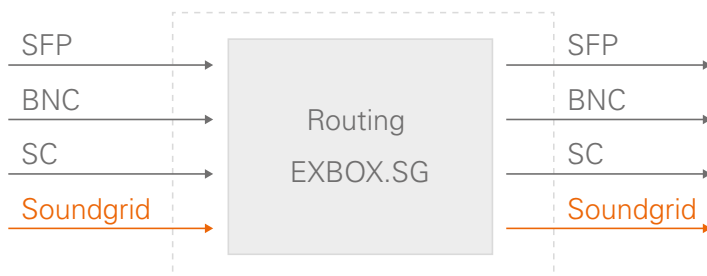

To setup globcon control please refer to "globcon control" on page 21.

CHAPTER 2: Legal issues & facts

Before Installing This Device



WARNING!

Please read and observe all of the following notes before installing this product:

- Check the hardware device for transport damage.
- Any devices showing signs of mechanical damage or damage from the spillage of liquids must not be connected to the mains supply, or disconnected from the mains immediately by pulling out the power lead.
- All devices must be grounded. The device is grounded through its IEC power connections.
- All devices must be connected to the mains using the three-cord power leads supplied with the system. Only supply electrical interfaces with the voltages and signals described in these instructions.
- Do not use the device at extreme temperatures. Proper operation can only be guaranteed between temperatures of 5° C and 45° C and a maximum relative humidity of 80 %, non-condensing.
- The cabinet of the device will heat up. Do not place the device close to heating sources (e.g. heaters). Observe the environmental conditions.

Defective Parts/Modules



WARNING!

This device contains no user-serviceable parts. Therefore do not open the device. In the event of a hardware defect, please send the device to your DirectOut representative together with a detailed description of the fault. We would like to remind you to please check carefully whether the failure is caused by erroneous configuration, operation or connection before sending parts for repair.

First Aid (in case of electric shock)

WARNING!



- Do not touch the person or his/her clothing before power is turned off, otherwise you risk sustaining an electric shock yourself.
- Separate the person as quickly as possible from the electric power source as follows:
 - Switch off the equipment.
 - Unplug or disconnect the mains cable.
- Move the person away from the power source by using dry insulating material (such as wood or plastic).
- If the person is unconscious:
 - Check their pulse and reanimate if their respiration is poor.
 - Lay the body down and turn it to one side. Call for a doctor immediately.
- Having sustained an electric shock, always consult a doctor.

Updates

DirectOut products are continually in development, and therefore the information in this manual may be superseded by new releases. To access the latest documentation, please visit the DirectOut website:
www.directout.eu.

This guide refers to micro firmware version 1.1.11 and control module version 12.1.0.258.

Intended Operation

EXBOX.SG is designed for conversion / routing between network audio and MADI signals. MADI refers to AES10, network audio refers to Soundgrid.



WARNING!

No compensation can be claimed for damages caused by operation of this unit other than for the intended use described above. Consecutive damages are also excluded explicitly. The general terms and conditions of business of DirectOut GmbH are applied.

Conditions of Warranty

This unit has been designed and examined carefully by the manufacturer and complies with actual norms and directives.

Warranty is granted by DirectOut GmbH over the period of 36 months for all components that are essential for proper and intended operation of the device. The date of purchase is applied for this period.

Consumable parts (e.g. battery) are excluded from warranty claims.



WARNING!

All claims of warranty will expire once the device has been opened or modified, or if instructions and warnings were ignored.

For warranty claims please contact the dealer where your device was acquired.

Conformity & Certificates

CE

This device complies with the basic requests of applicable EU guidelines. The appropriate procedure for approval has been carried out.

RoHS

(Restriction of the use of certain Hazardous Substances)

This device was constructed fulfilling the directive on the restriction of the use of certain hazardous substances in electrical and electronic equipment 2011/65/EU and 2015/863.

WEEE

(Directive on Waste Electrical and Electronic Equipment)

Due to the directive 2002/96/EC for waste disposal this device must be recycled.

For correct recycling please dispatch the device to:

DirectOut GmbH,

Leipziger Str. 32

09648 Mittweida

Germany

Only stamped parcels will be accepted!

WEEE-Reg.-No. DE 64879540

Contact

DirectOut GmbH

Leipziger Str. 32, 09648 Mittweida, Germany

Phone: +49 (0)3727 5665-100

Fax: +49 (0)3727 5665-101

Mail: sales@directout.eu

www.directout.eu

Contents

The contents of your EXBOX.SG package include:

- 1 x EXBOX.SG
- 1 x external power supply unit (9 - 24 V)
- 1 x Instruction Leaflet

Remote Control

The device is managed via globcon remote control. To manage the Soundgrid network a Soundgrid host application (e.g. Soundgrid Studio or QRec) is required.

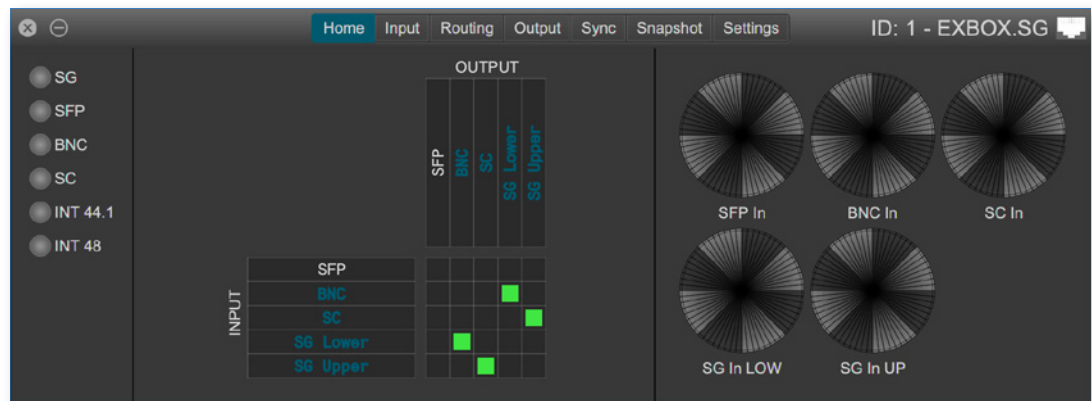

globcon is a free, global control software platform for the management of professional audio equipment. Most products of the DirectOut product portfolio are supported by globcon.

Link: www.globcon.pro

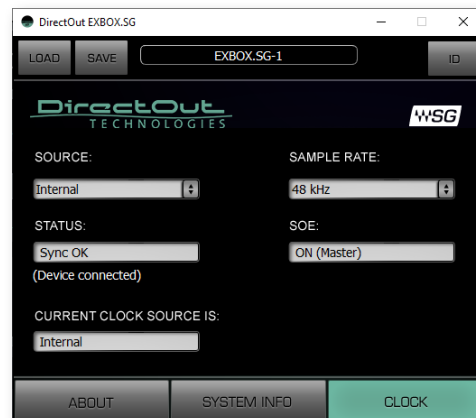

Soundgrid control panel launched from Soundgrid Studio or QRec

Link: www.waves.com

Accessory

Two different optical SFP transceiver for MAD1 transmission are available from DirectOut GmbH:

- Multimode SFP transceiver with LC connectors (No: DOICT0129)
- Singlemode SFP transceiver with LC connectors (No: DOICT0130)

Specification of the optical SFP modules:

SFP	Multimode	Singlemode
Wavelength TX nominal	1310 nm	1310 nm
Wavelength RX nominal	1310 nm	1310 nm
Distance	2 km	10 km
Powerbudget (dB)	> 11 dB	> 12 dB
Protocols	Fast Ethernet OC3/STM1	Gigabit Ethernet, Gigabit Fibre Channel
Bandwidth from	100 Mbit/s	1.050 Gbit/s
Bandwidth	155 Mbit/s	1.250 Gbit/s
Laser	FP	FP
Receiver Type	PIN	PIN
Connector	LC	LC
Wavelength TX min	1260 nm	1260 nm
Wavelength TX max	1360 nm	1360 nm
Wavelength RX min	1260 nm	1260 nm
Wavelength RX max	1620 nm	1600 nm
Transmit min	- 19.00 dBm	- 9.00 dBm
Transmit max	- 14.00 dBm	- 3.00 dBm
Receive min	- 30 dBm	- 21.00 dBm
Receive max (Receiver overload)	- 5.00 dBm	- 3.00 dBm
Temperature (min)	0° Celsius	0° Celsius
Temperature (max)	70° Celsius	70° Celsius
Type of DDM/DOM	internal	internal
Extinction Ratio	8.20 dB	9 dB

BOXMOUNT XL- for optimal rack mount of up to three devices in a 19" frame
(No: DOAPA0886):



Chapter 3: Installation

Installing the Device

1. Open the packaging and check that the contents have been delivered complete and undamaged.
2. Place the device on a non-slip horizontal surface. The delivered pads may be affixed to the bottom of the cabinet. Ensure a clean and dry surface before affixing the pads.

WARNING!



The synthetics of the delivered pads might cause stains on damageable surfaces. To avoid staining of furniture surfaces it is recommended to place a protective plate under the device.

WARNING!



Avoid damage from condensation by waiting for the device to adapt to the environmental temperature. Proper operation can only be guaranteed between temperatures of 5° C and 45° C and a maximum relative humidity of 80%, non-condensing.

Ensure that the unit has sufficient air circulation for cooling.

3. Remove the protective cap from the optical MADi port(s) before use.



NOTE



Retain the protective cap if the optical port is unused. This will protect against soiling which can lead to malfunction.

4. Connect signal cable(s) for the MADI signals.



5. Plug in the network cable to the ethernet port(s) to connect the device with your computer or other Soundgrid device.

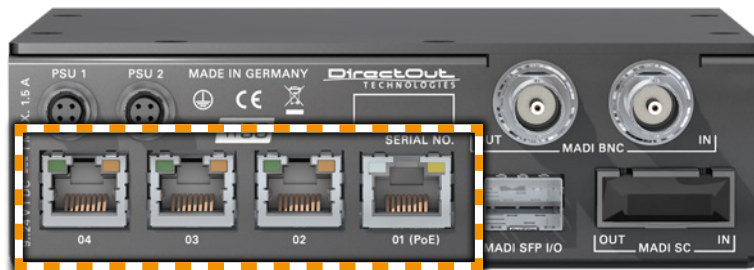

Soundgrid networking technology is based on layer 2 and no IP configuration is required. globcon is connected via MIDI over ethernet.



NOTE

Use appropriate network cables (CAT5E or better).



NOTE

The network shall be used with SoundGrid only. Do not share it with the internet or other networks.

6. Using the power cord of the external power supply provided, connect the device to a matching power supply and connect the output of the power supply to the Hirose connectors at the rear panel.



This device may operate with only one power supply. To provide power supply redundancy, it is recommended to connect both PSU 1 and PSU 2 to independent power supplies with separate fuses.

NOTE



The shipment includes one external power supply unit. Additional power supply units are available from your local DirectOut representative.

WARNING!



The external power supply must be connected to the mains using the three-cord power leads supplied with the device. Only supply the voltages and signals indicated (9 - 24 V DC) to the device.

WARNING!



The connected power supply must provide a current limiting to a maximum of 2.5 A.

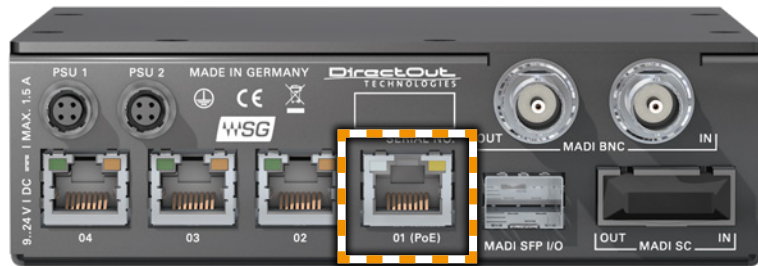

Power over Ethernet

The device can also be operated via a power over ethernet connection. Connect the port labelled '01 (PoE)' to an appropriate PoE switch (PoE Class 0 / 0.4 - 13W, IEEE 802.3af).



WARNING!

Never connect a PoE link to a network interface that is not marked explicitly for PoE operation. The voltage supplied there may damage the interface.



TIP

Keep any packaging in order to protect the device should it need to be dispatched for service.

7. Download 'Waves Central' for Mac or PC, as needed.
Link: www.waves.com > Downloads > Latest Version
8. Run the installer and follow the onscreen instructions when finished.
Launch Waves Central and login with your Waves account.
9. Click on 'INSTALL PRODUCTS' and select 'ALL PRODUCTS'.
Type 'directout' into the search field to filter the driver listing.

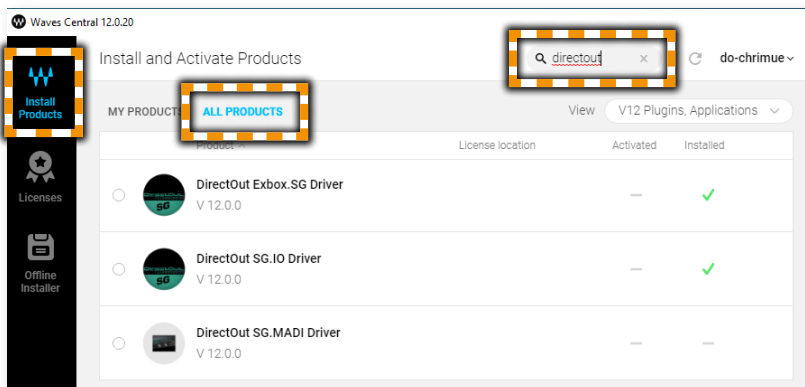

10. Select 'DirectOut Exbox.SG Driver' and click install.

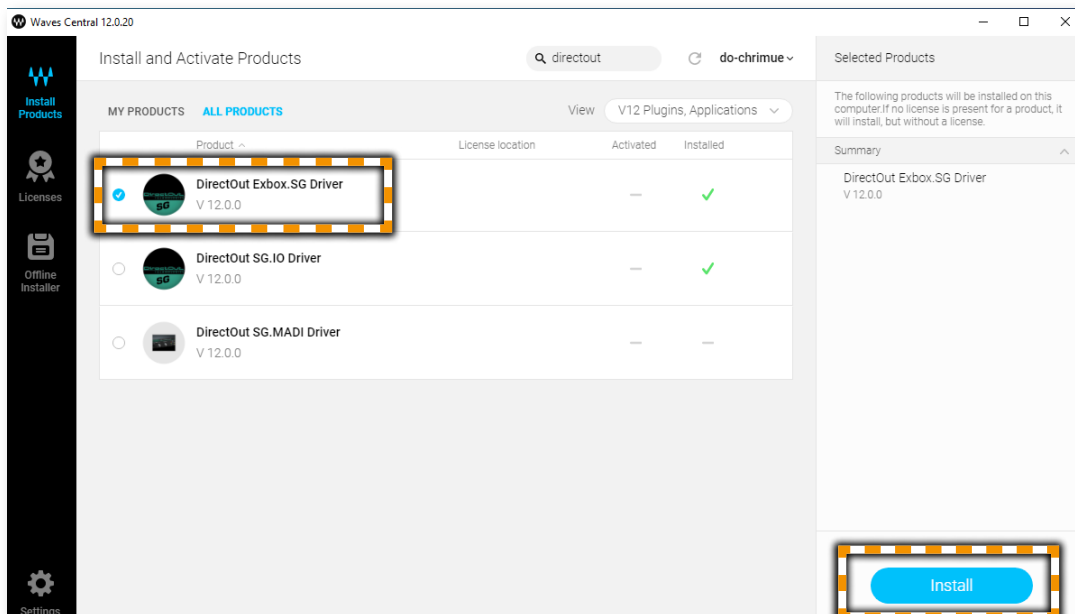

When the installation procedure has finished a restart of the computer is required.

11. Launch Soundgrid Studio and confirm to add EXBOX.SG to Soundgrid Studio.

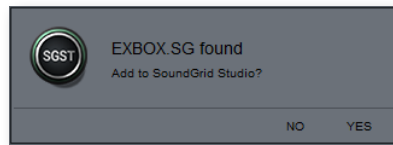

12. Select the tab 'SETUP' for the device overview.
EXBOX.SG is displayed at 'I/O DEVICES'.

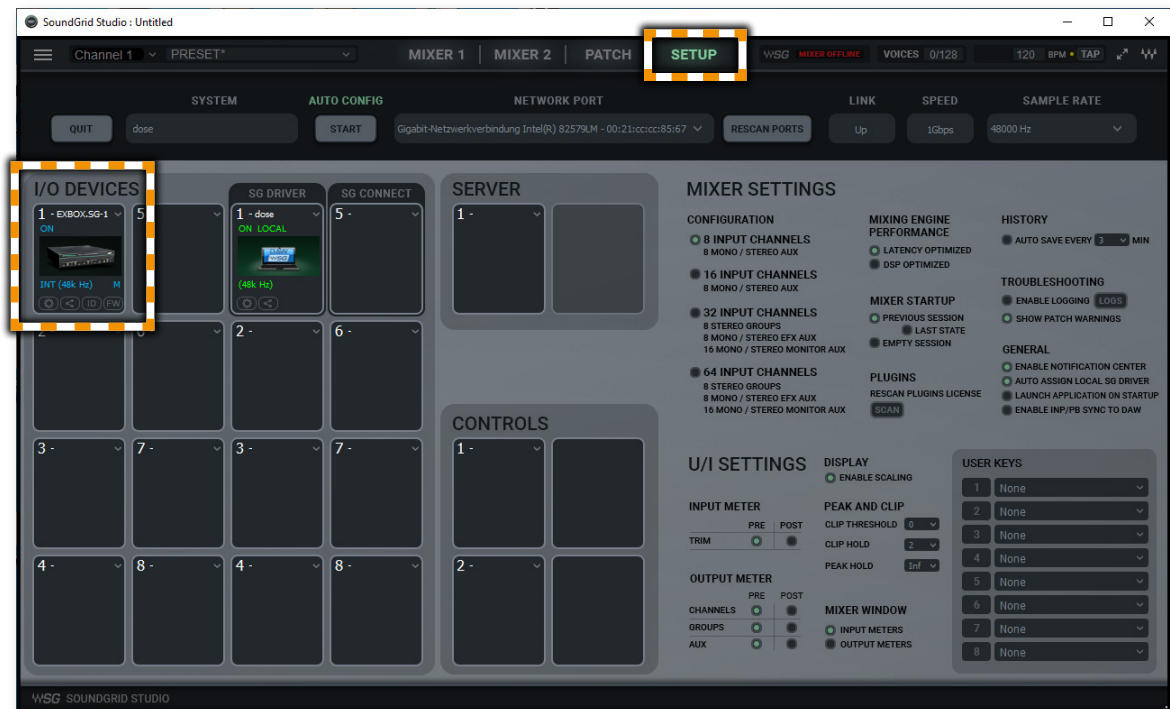

The control icons at the bottom (from left to right):

- open the control panel of the device
- share Soundgrid driver
- identify device (led STATE will flash in different colors)
- indicator of old firmware or initiate firmware update

WARNING

Never disconnect any connection (network, power supply) during the firmware update process. Disconnecting may lead to a defective device state which may require to return the device to factory.

13. Click the arrow down-key to pull down the menu and assign the device to the Soundgrid MIDI driver (this is required for globcon control).



14. Download and install globcon on your computer.

Link: www.globcon.pro

15. Launch globcon and open the Preferences (Settings/Preferences). Add the MIDI IO ('SG Device I/O') and activate MIDI to enable device discovery for EXBOX.SG. 'Apply' the changes.

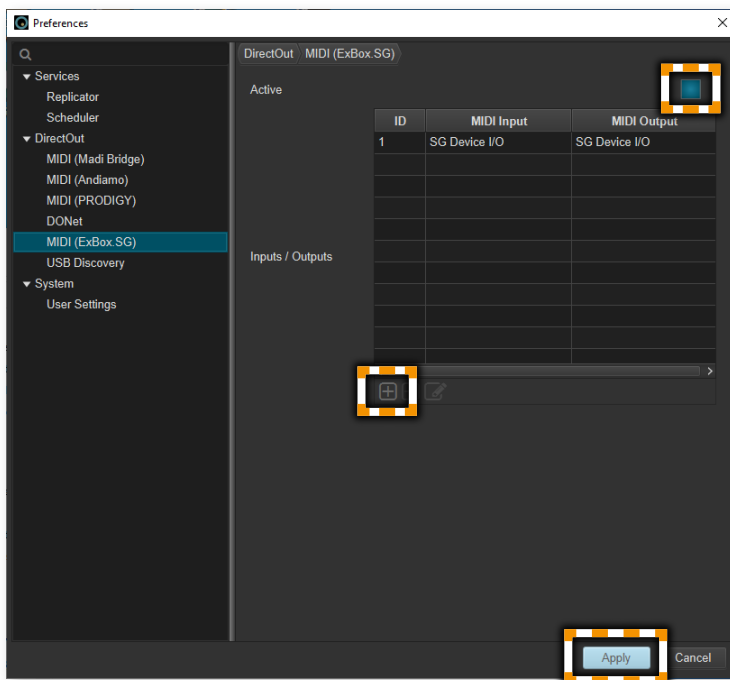

- 16.** Click 'Discovery Methods' and check that MIDI (EXBOX.SG) is active. EXBOX.SG is listed then.

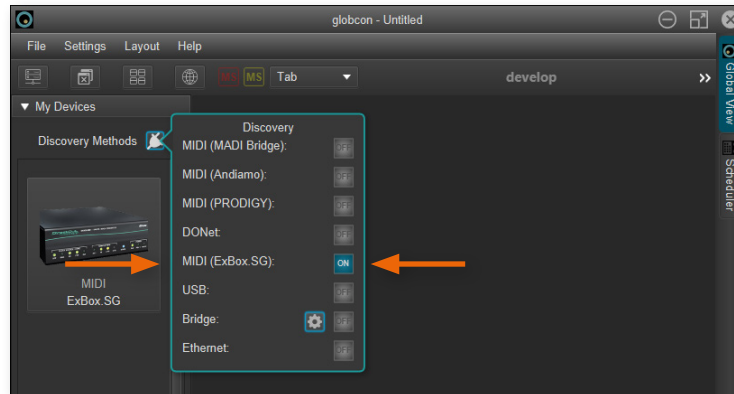

- 17.** Click to add it to the workspace. Double-click the tiny display of the device to open the control.



NOTE

To access the device via globcon the Soundgrid host application must be running and the device needs to be assigned to the Soundgrid MIDI driver.

CHAPTER 4: Operation

Introduction

This chapter describes the basic operation of the device.

Note that throughout this manual, the abbreviation FS refers to sample rate or sample frequency. So, when dealing with scaling factors, the following sample rates can be written as:

- 44.1 kHz or 48 kHz = 1 FS
- 88.2 kHz or 96 kHz = 2 FS
- 176.4 kHz or 192 kHz = 4 FS

NOTE



Scaling factor 4 FS is currently not supported by Soundgrid.

Global Control

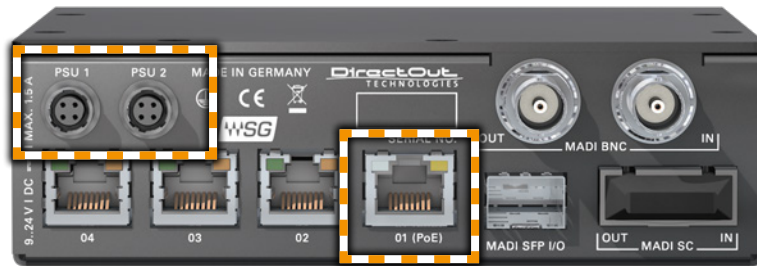

PSU 1	Hirose socket Connect the power supply here (9- 24 V DC).
PSU 2	Hirose socket Connect the power supply here (9- 24 V DC).
01 (PoE)	RJ45 socket Connect PoE link here. PoE Class 0 / 0.4 - 13 W



NOTE

The device does not provide a power switch. Connecting a working power supply to the device will power up the device immediately.



WARNING!

Never connect a PoE link to a network interface that is not marked explicitly for PoE operation. The voltage supplied there may damage the interface.



POWER	LED green - indicates state of power supply
PSU 1	○ (OFF) = power supply not working
PSU 2	● (ON) = power supply working
PoE	

Input / Output - MADI

Three different MADI ports enable flexible connectivity in various scenarios. Due to the device's routing capabilities format conversion between different MADI formats is possible.

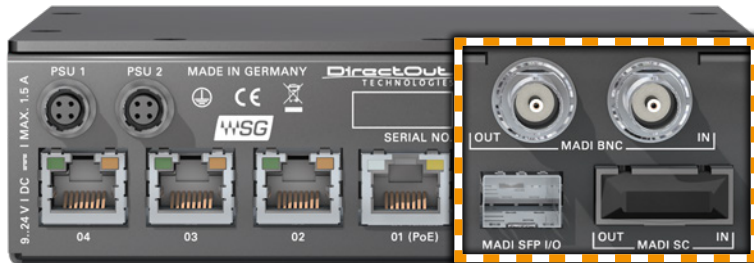





MADI BNC OUT	BNC socket MADI output - connect here for MADI output signal.
MADI BNC IN	BNC socket* MADI or WCK input - connect MADI or word clock input signal here.
MADI SC OUT	SC socket MADI output - connect here for MADI output signal.
MADI SC IN	SC socket MADI input - connect MADI input signal here.
MADI SFP I/O	SFP socket Insert SFP module here and connect MADI input/output.

* The BNC input may be operated as word clock input (AES11) - see p 29.

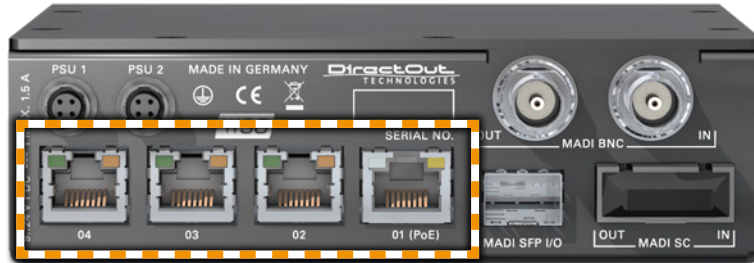
Input / Output - Network

Four network ports are available for transmission of audio signals and remote control. Four network ports are connected with the built-in switch.



01 (PoE)	RJ45 socket (1 Gbit/s) Network interface - connect here for network transmission. This port accepts a PoE source for power supply - see page 24.
02	RJ45 socket (1 Gbit/s) Network interface - connect here for network transmission.
03	RJ45 socket (1 Gbit/s) Network interface - connect here for network transmission.
04	RJ45 socket (1 Gbit/s) Network interface - connect here for network transmission.
LED left (Port 1 to 4)	LED orange - indicates the link state of the network connection*.  (ON) = device link active  (OFF) = device link not active
LED right (Port 1 to 4)	LED green - indicates the activity state of the network connection.  (ON) = data sent or received  (OFF) = no data transmission

* Some possible reasons that lead to an inactive link:

- device switched off
- connected device switched off
- cabling issue

Input State / Clocking

Five LEDs inform about the state of each signal input and the selected clock source of the device.

The device offers several options for clocking:

- Soundgrid (Sync over Ethernet = SoE)
- MADI input
- Word Clock (@ MADI BNC input)*
- internal clock generator



CLOCK SOURCE / SYNC	LED - indicates selected clock source and the lock / sync state of MADI input, SoE or the internal clock generator.
SFP	○ (OFF) = no signal lock
BNC*	◐ (50 % green) = signal lock, in sync
SC	◑ (100 % green) = signal lock, in sync, selected clock source
PTP	⚠ (blinking red) = signal lock, not in sync with selected clock source
INT	◑ (blinking green) = input selected as clock source and no signal lock.

* See "Clocking to word clock" on page 29

Clocking is set in:

- device control panel of Soundgrid - to adjust the Soundgrid part
- globcon - when dealing with external clock sources (MADI or input, Word Clock input) or the internal clock generator of EXBOX.SG

The device control panel offers:

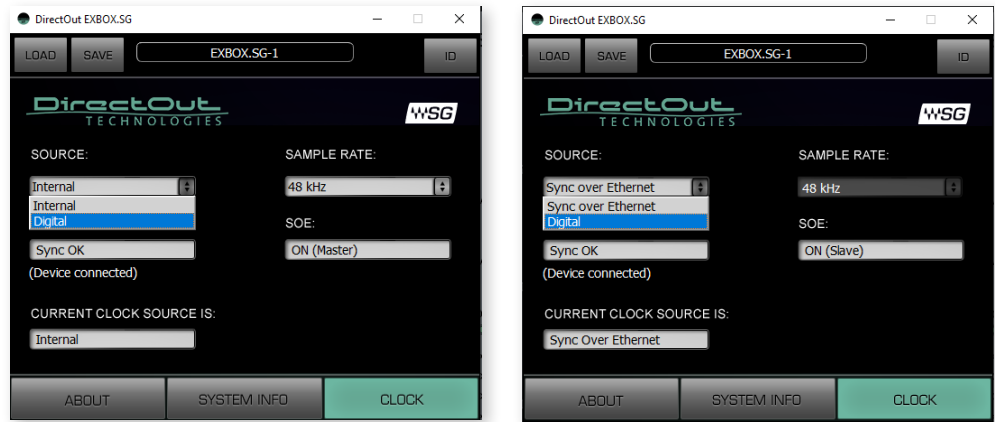

Internal*	Clock source is provided by the Soundgrid module of the device and device acts as SoE clock master. Other devices in the Soundgrid network will lock to it.
Sync over Ethernet**	Clock source is provided by Soundgrid network. Device acts as SoE slave.
Digital***	Clock source is provided by external sources of EXBOX.SG (MADI input, Word Clock input) or by the internal clock generator.

* available when device is SoE clock master

** available when device is SoE clock slave

*** clock source is set in globcon

The globcon 'Sync' tab to adjust clock source:

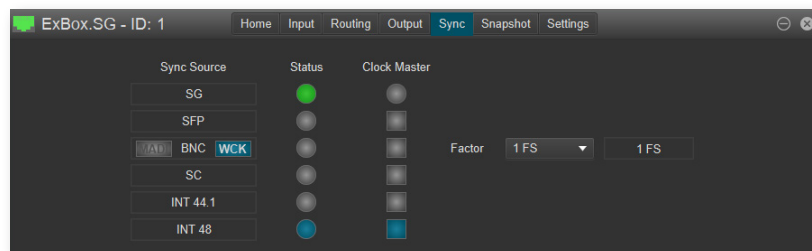

NOTE

This setting is relevant and accessible only when the device control panel is set to 'DIGITAL'.

Soundgrid Master

In setups with multiple Soundgrid devices the Soundgrid Master (SoE master) is set manually in the SETUP of the host application (e.g. Soundgrid Studio). All devices connected to the Soundgrid network will lock to the SoE master - see "Clocking Soundgrid network" on page 33.

TIP



EXBOX.SG can be synced from a digital source (MADI, word clock or the internal generator) and act as SoE master.

Clocking to word clock

The BNC MADI input also accepts a word clock signal according to AES11. The operating mode of the BNC input is selected in globcon - see page 40.

CLOCK SOURCE / SYNC	LED - indicates selected clock source and the lock / sync state of MADI BNC / WCK input.
BNC	<ul style="list-style-type: none"> ○ (OFF) = no signal lock ◐ (50 % green) = signal lock, in sync ◑ (100 % green) = signal lock (MADI), in sync, selected clock source ◑ (100 % purple) = signal lock (WCK), in sync, selected clock source ⦿ (blinking red) = signal lock, not in sync with selected clock source ⦿ (blinking green) = input selected as clock source (MADI) and no signal lock. ⦿ (blinking purple) = input selected as clock source (WCK) and no signal lock.

Independent from the operating mode of the MADI BNC input the MADI BNC output does output a MADI signal.

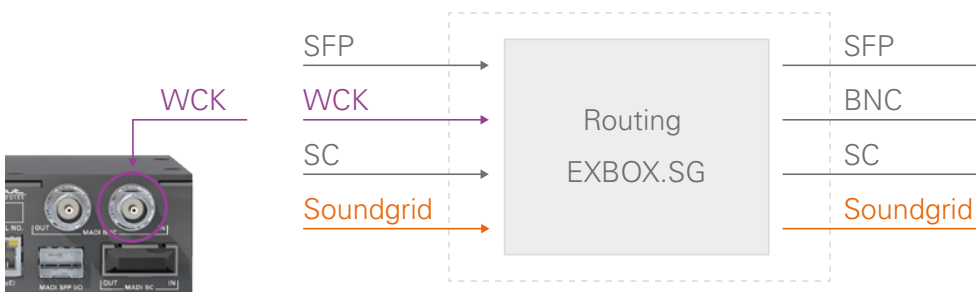

Sample Rate

The base rate (44.1 kHz, 48 kHz) and the scaling factor (1 FS, 2 FS, 4 FS) is displayed by four LEDs at the front panel.



NOTE

At higher sample rates the number of audio channels is reduced depending on the integer of the scaling factor:

- 128 channels at 1 FS
- 64 channels at 2 FS

4 FS operation is not supported by Soundgrid.

SAMPLE RATE 44.1k	<p>LED green - indicates the base rate of the audio engine.</p> <p>○ (OFF) = base rate is different from 44.1 kHz ● (ON) = base rate of 44.1 kHz (or multiple of) is used</p>
SAMPLE RATE 48k	<p>LED green - indicates the base rate of the audio engine.</p> <p>○ (OFF) = base rate is different from 48 kHz ● (ON) = base rate of 48 kHz (or multiple of) is used</p>
SAMPLE RATE 2 FS	<p>LED yellow - indicates the scaling factor of the base rate.</p> <p>○ (OFF) = scaling factor is 1 FS ● (ON) = scaling factor is 2 FS ☀ (blinking) = scaling factor does not match the sample rate of the SG module.</p>

State

The status of the Soundgrid module is monitored by a LED at the front.

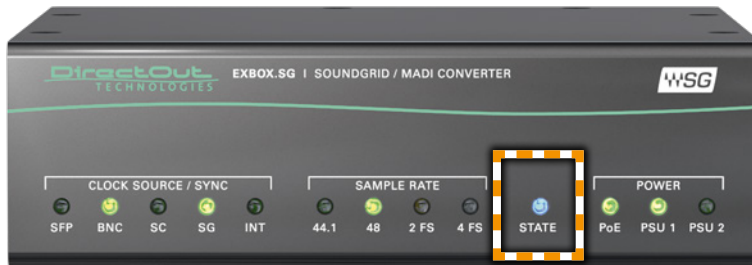

STATE	<p>LED RGB - indicates the state of the SG module.</p> <ul style="list-style-type: none"> ○ (OFF) = module not available ● (ON, blue) = module is working ⦿ (blinking, blue) = module in failsafe mode* ⦿ (blinking, red) = module is not connected with Soundgrid network ⦿ (blinking, rainbow) = identify device active ● (ON, yellow) = firmware update in progress or finished
-------	---

* The Soundgrid module starts into failsafe mode if its firmware is corrupted. This may happen in very rare cases only. Should you encounter this state, please contact support for further information.

CHAPTER 5: Controlling

The device is managed via globcon remote control (p 38). To manage the Soundgrid network a Soundgrid host application is required (p 32 / p 35). For access via globcon the Soundgrid MIDI driver must be assigned first (p 21).

Soundgrid - Host

The remote control of EXBOX.SG requires a Soundgrid host application such as Soundgrid Studio, MultiRack Soundgrid or eMotion LV1 being installed. From here the control panel for EXBOX.SG can be launched (p 35).

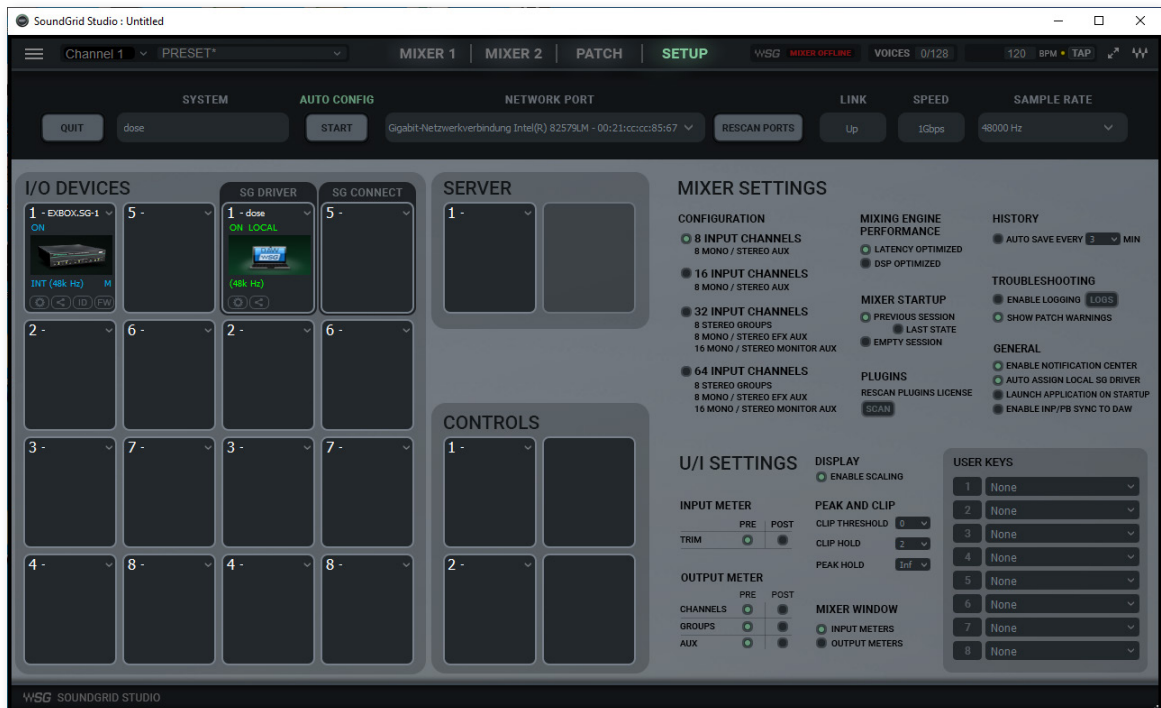

Soundgrid Studio in setup mode showing EXBOX.SG in the device rack of the system inventory.

Next to the device there are four buttons:

Control wheel	Button Click to open the control panel for EXBOX.SG
Share	Button Click to share driver I/O with up to five hosts.
ID	Button. Click to show a rainbow pattern on the LED 'STATE' at the front panel.
FW	Indicates the status of the device's firmware grey = firmware compatible blue = firmware compatible, but newer version exists red = firmware not compatible and must be updated in order to use.

Firmware Update

An I/O that is using outdated or incompatible firmware will not work properly in a Soundgrid network until its firmware is updated. If a device requires updated firmware, click on the FW button to start a hardware scan.

WARNING



Do not disconnect the device or turn off the computer before 'Done' appears. Once the update is ready, turn the device off and on to reset.

Soundgrid driver - Number of channels

The number of channels of the SG driver can be adjusted in the SETUP.

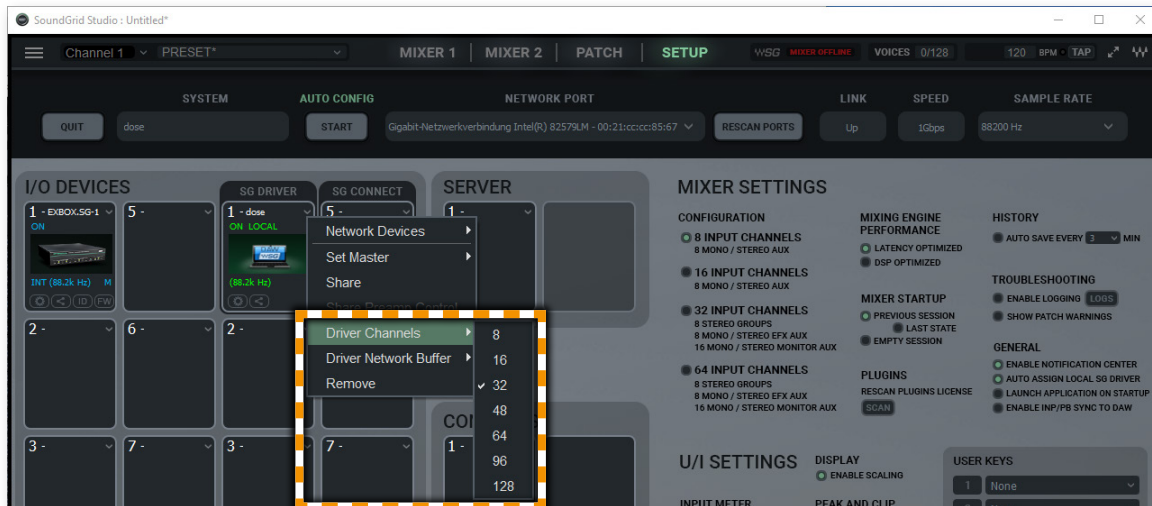

Clocking Soundgrid network

In setups with multiple Soundgrid devices the Soundgrid Master (SoE master) is set manually. All devices connected to the Soundgrid network will lock to the SoE master.

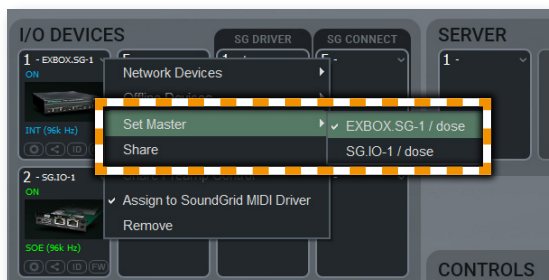

Signal Routing - Soundgrid

To setup your signal routing between Soundgrid devices open the tab ,PATCH' and switch to the routing matrix ,DEVICE TO DEVICE. With EXBOX.SG connected you should see 128 channels of Soundgrid @ 1FS (or 64 channels @ 2 FS).

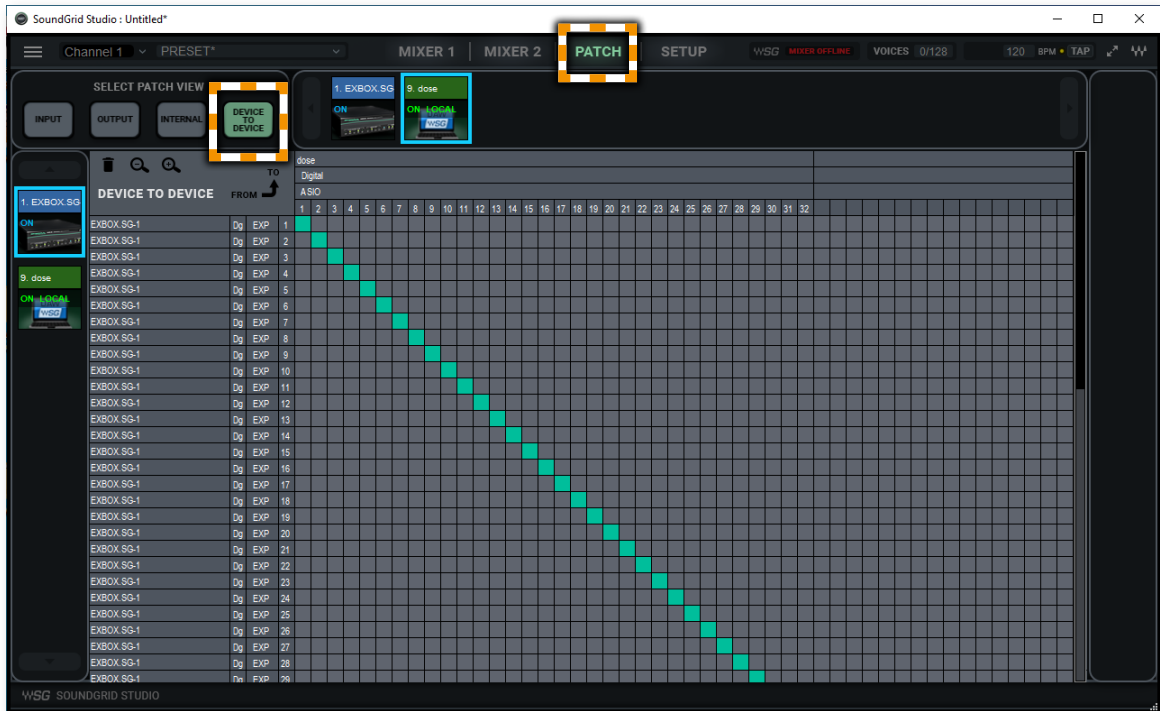

Signal Routing - MADI

The signal routing between the three MADI IOs and Soundgrid is managed in globcon. Entire ports can be patched only.

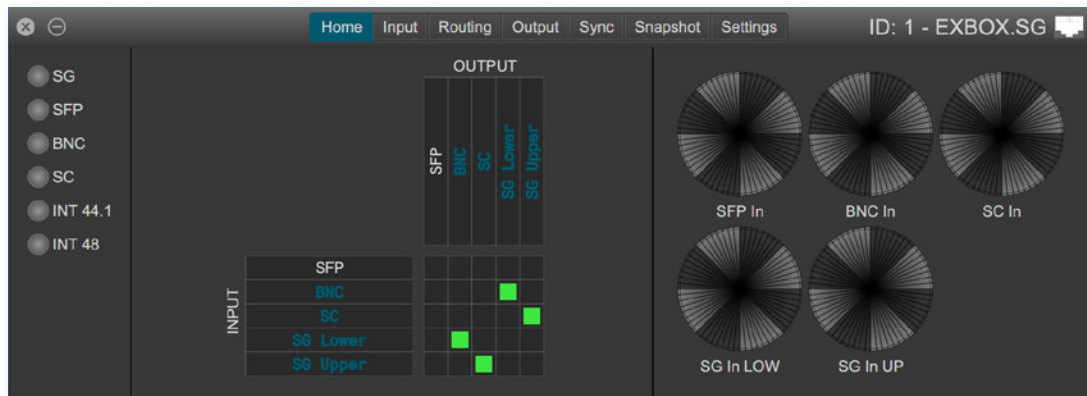

Soundgrid - EXBOX.SG Control

The control panel is organized into different tabs:

- ABOUT = device overview
- SYSTEM INFO = hardware related information
- CLOCK = clock settings and status info for EXBOX.SG

To navigate click on the corresponding button at the bottom.



Tab 'ABOUT' displaying the device information.

LOAD	Button Click to load a stored session.
SAVE	Button Click to restore a session from file.
EXBOX.SG-1	Text field displaying the name of the device. Click to edit the name
ID	Button Click to show a rainbow pattern on the LED 'SG STATE' at the front panel.

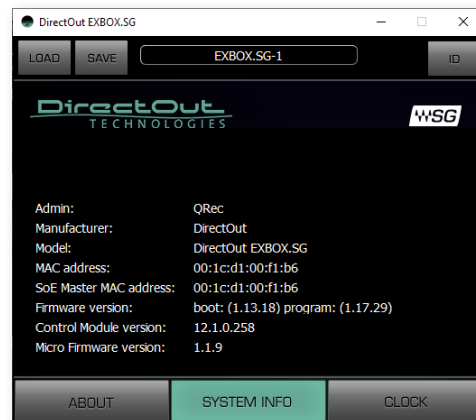

Tab 'SYSTEM INFO' displaying hardware related information.

Display of MAC address, SOE master MAC Address, firmware version, and more. You may need this information for support incidents.

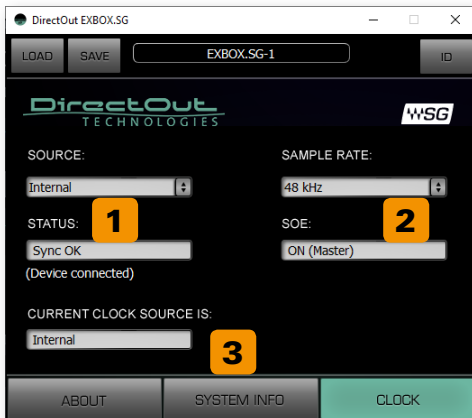

Tab 'CLOCK' to set and manage the clock source for the device.

1 SOURCE

Internal*	Clock source is provided by the Soundgrid module of the device and device acts as SoE clock master. Other devices in the Soundgrid network will lock to it.
Sync over Ethernet**	Clock source is provided by Soundgrid network. Device acts as SoE slave.
Digital***	Clock source is provided by external sources of EXBOX.SG (MADI input, Word Clock input) or by the internal clock generator.

* available when device is SoE clock master

** available when device is SoE clock slave

*** clock source is set in globcon - see page 40.

2 SAMPLE RATE

Sample Rate	Sets the sample rate when Clock Source is set to Internal. Range: 44.1 / 48 / 88.2 / 96 kHz
-------------	--

3 CLOCK STATUS INDICATORS

STATUS	Displays Sync state
SOE	Displays state of Sync over Ethernet (SoE master, slave or off).
CURRENT CLOCK SOURCE	Displays current clock source. May differ from SOURCE setting if selected source becomes invalid.

globcon - EXBOX.SG plugin

The plugin panel is organized into different tabs:

- Home = device overview (Sync, Routing, Level Metering)
- Input = status of MAD I input
- Routing = signal routing of local IOs
- Output = setting for MAD I output
- Sync = settings/monitoring of device sync
- Snapshot = snapshot management
- Settings = device information

To navigate click on the corresponding button at the top.

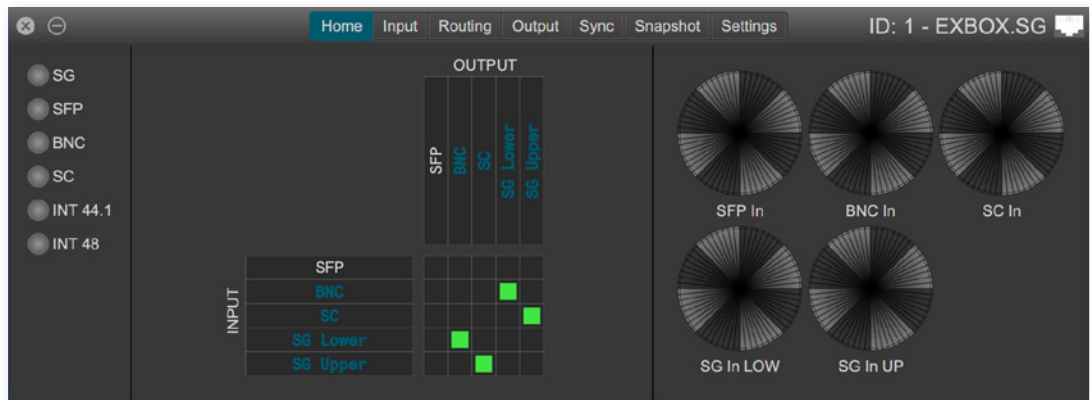

Tab 'Home' displaying Sync Info, Routing, level metering

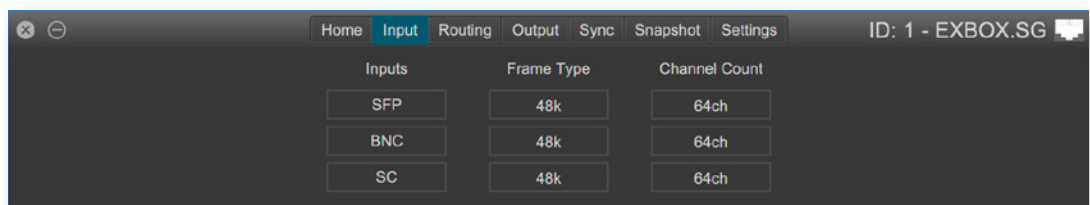

Tab 'Input' displaying Frame Format and Channel Mode of MAD I input signals.

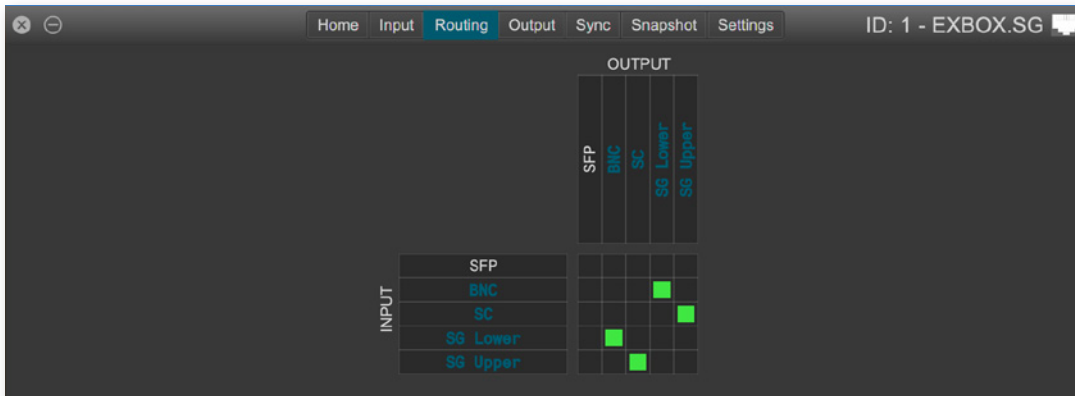

Tab 'Routing' to setup the signal routing between local IOs (MADI, Soundgrid).

- Click into a square to patch / un-patch input and output.
- A patch is displayed by a green square.
- Signal routing is available on a port basis only.

SFP	MADI I/O (64 channels @ 1 FS, 32 channels @ 2 FS)
BNC	MADI I/O (64 channels @ 1 FS, 32 channels @ 2 FS)
SC	MADI I/O (64 channels @ 1 FS, 32 channels @ 2 FS)
SG Lower	Soundgrid channel 01 to 64 (@ 1 FS) or 01 to 32 (@ 2 FS).
SG Upper	Soundgrid channel 65 to 128 (@ 1 FS) or 33 to 64 (@ 2 FS).

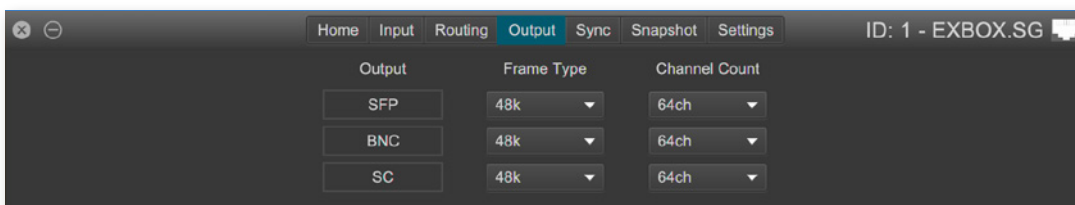

Tab 'Output' setting Frame Format and Channel Mode of MADI output signals.

Frame Type	Frame Format of MADI output (48 kFrame / 96k Frame)
Channel Count	Channel Mode of MADI output (64 ch / 57 ch / 56 ch)

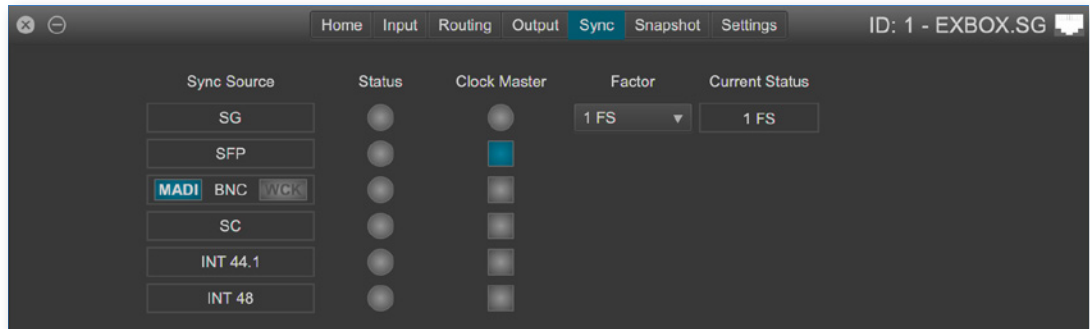

Tab 'Sync' to manage the clocking of the device depending from the clock setting in the Soundgrid control panel - see "Soundgrid Clock Setting" on page 37.

Sync Source	Inputs that can be used for clocking (Soundgrid, MADI, word clock) or the internal clock generator (INT). See page 27.
Status	Display of lock / sync status of the sync source <input type="radio"/> (grey) = no signal lock <input checked="" type="radio"/> (blue) = signal lock, clock master <input type="radio"/> (green) = signal lock, in sync with clock master <input type="radio"/> (blinking green) = signal lock, not in sync with clock master
Clock Master	Buttons to set the clock master Click the square to set the sync source. The setting becomes relevant when the 'SOURCE' in the Soundgrid control panel is set to 'Digital' - see page 37. <input type="checkbox"/> (grey) = not set as clock source <input checked="" type="checkbox"/> (blue) = set as clock source
Factor*	Menu to set the scaling factor (1 FS or 2 FS) in order to match the MADI IO with sample rate.
Current Status	Display of the current scaling factor.

* The set scaling factor can be overruled by the clock source - i.e. Soundgrid sample rate setting or MADI input with 96k Frame. The LED 2 FS will blink to indicate a mismatch - see "Sample Rate" on page 30. The detected scaling factor is displayed at 'Current Status'.

Sync Settings - Overview

Soundgrid control panel	globcon	Clock Master of EXBOX.SG	SoE Master
Internal	setting not relevant	Soundgrid Module	EXBOX.SG
Sync over Ethernet			other SG device
Digital	SFP	MADI @ SFP input	EXBOX.SG or other SG device*
	BNC MADI	MADI @ BNC input	
	BNC WCK	WCK @ BNC input	
	SC	MADI @ SC input	
	INT 44.1	Internal clock generator @ 44.1 kHz	EXBOX.SG
	INT 48	Internal clock generator @ 48 kHz	

* If several devices in the Soundgrid network are synced to a common clock source (e.g. word clock) either one can act as the SoE Master - see "Appendix D: Application Examples" on page 50.

CHAPTER 6: Troubleshooting and Maintenance

Troubleshooting

To identify a possible defect with the device please consult the following table. If the fault cannot be resolved using these instructions, please contact your local DirectOut representative or visit support.directout.eu.

Issue	Possible reason	Solution
Device doesn't work.	Power supply is broken.	Check that the power supply switch is on, that the device is connected to the power supply and that the socket is working. Defective fuses must be exchanged by qualified service personal only.
Optical port does not work.	Optic is dirty.	Use an air supply to carefully remove any dust. Never use objects for cleaning.
No signal at the output port.	Connections (input / output) are mixed up.	Check the connections and change the cables if necessary. Check the routing matrix.
No signal at the output port.	Signal cable defective.	Exchange the signal cable.
No signal at the output port.	Connectors of the signal cable are dirty.	Use an air supply to carefully remove any dust. Never use objects for cleaning. or Exchange the signal cable.
MADI signal at the input is not stable.	Signal source is defective or bad signal condition (Jitter > 1 ns)- e.g. due to exceeded length or bad screening attenuation of signal cable.	Change the source or use appropriate cables.

Maintenance

To clean the device, use a soft, dry cloth. To protect the surface, avoid using cleaning agents.

NOTE

The device should be disconnected from the power supply during the cleaning process.



CHAPTER 7: Technical Data

Dimensions

- Width 140 mm
- Height 42 mm
- Depth 146 mm

Weight

- 0.7 kg

Power Consumption

- 9 W (typical)

Power Supply

- 2 x Hirose socket (HR10)
- 9 V- 24 V DC (external)



WARNING!

The connected power supply must provide a current limiting to a maximum of 2.5 A.

Environmental Conditions

- Operating temperature +5°C up to +45°C
- Relative humidity: 10%- 80%, non condensing

MADI Ports SC optical

- SC socket FDDI (input / output)
- ISO/IEC 9314-3
- Wave length 1310 nm
- Multi-Mode 62.5/125 or 50/125

MADI Ports BNC coaxial

- BNC socket (input / output)
- Impedance: 75 Ω
- 0.3 V up to 0.6 V (peak to peak)

MADI Ports SFP

- empty cage without module

Sample Rate (for MADI and Word Clock)

- 30 - 50 kHz @ 1 FS
- 60 - 100 kHz @ 2 FS

MADI Format (I/O)

- 48k Frame, 96k Frame
- 56 channel, 57 channel, 64 channel

Network

- 4 x RJ45 socket
- Gigabit Ethernet
- for transmission of network audio, control data and firmware updates
- Network-Layer 2
- 128 channels I/O @ 1 FS (64 channels @ 2FS)
- Standard: Soundgrid

PoE (Network Port 1)

- PoE Class 0 / 0.4 - 13W
- IEEE 802.3af

Appendix A - Wiring Sketches

Hirose HR10 (DC PSU)

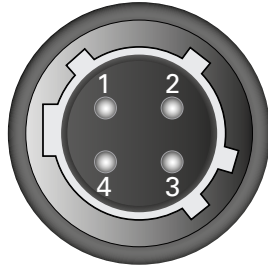

Pin	Signal
1	DC +
2	DC +
3	DC -
4	DC -



NOTE

To ensure proper operation all pins should be connected.



NOTE

Ground is connected with the chassis of the plug (safety class 1).

Appendix B - Working with ch 57 mode

Channel mode 57 ch on the MADl output enables transparent pass-through of embedded control data that is used by DiGiCo consoles.

Ch 57 mode is detected at the MADl input automatically and signaled to the user.

To preserve the control data throughout the signal chain:

- set MADl output to 57 ch mode
- route input channel 57 to output channel 57

The control data is preserved also across a Soundgrid connection to another EXBOX.SG or SG.IO, where it is output to MADl.

NOTE



The incoming control data is neither examined nor altered by the device.

Appendix C - Firmware Update

The device is updated via network from a Soundgrid host application (e.g. Soundgrid Studio).

The firmware update will update the host device and the Soundgrid module.

The Soundgrid host application is displaying the status of the firmware:

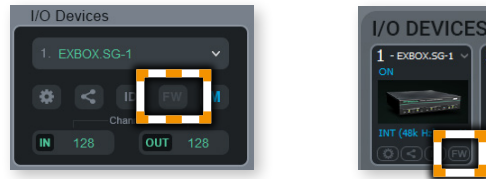

- grey = firmware compatible
- blue = firmware compatible, but newer version exists
- red = firmware not compatible and must be updated in order to use.

If a device requires updated firmware, click on the FW button to start a hardware scan.



WARNING

Do not disconnect the device or turn off the computer before 'Done' appears. Once the update is ready, turn the device off and on to reset.



WARNING!

It is strongly recommended to backup the device configuration (Save Session) before running any update.

This page is left blank intentionally.

Appendix D: Application Examples

Example 1 - Soundgrid < > MADI



- EXBOX.SG is connected to a Soundgrid host, running a DAW application.
- The mixing console is connected via MADI.
- Clocking: EXBOX.SG is SoE master, clock source 'SG', SG sync source 'Internal'

Example 2 - Mixing with Plugin Server

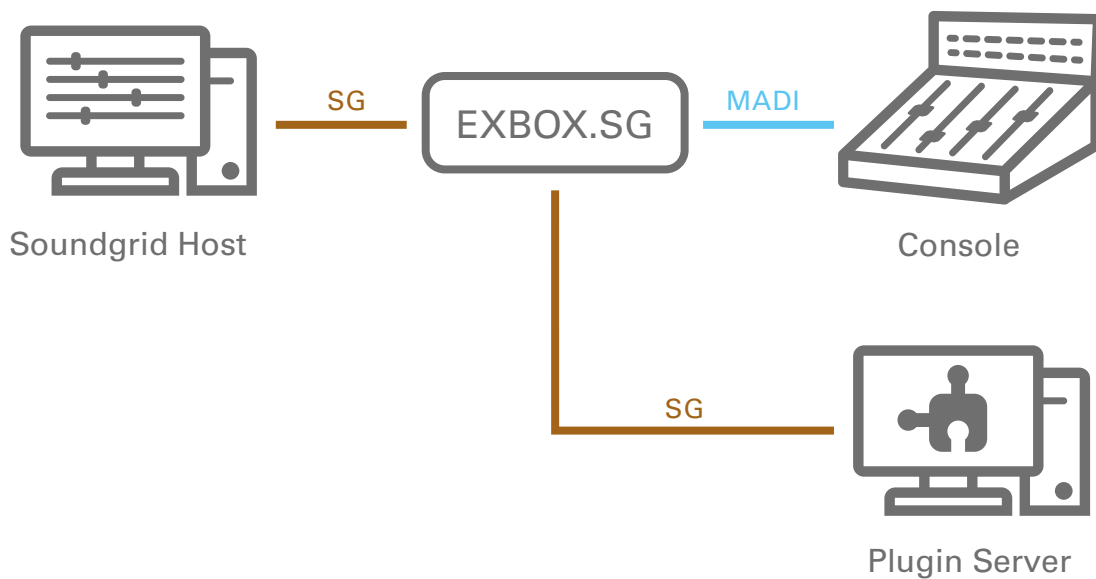

- EXBOX.SG connects the Soundgrid host (DAW) and the plugin server.
- The mixing console is connected via MADI.
- Clocking: EXBOX.SG is SoE master, clock source is MADI from the console, SG sync source 'Digital', globcon: MADI

Example 3 - Mixing with Plugin Server and multiple IOs

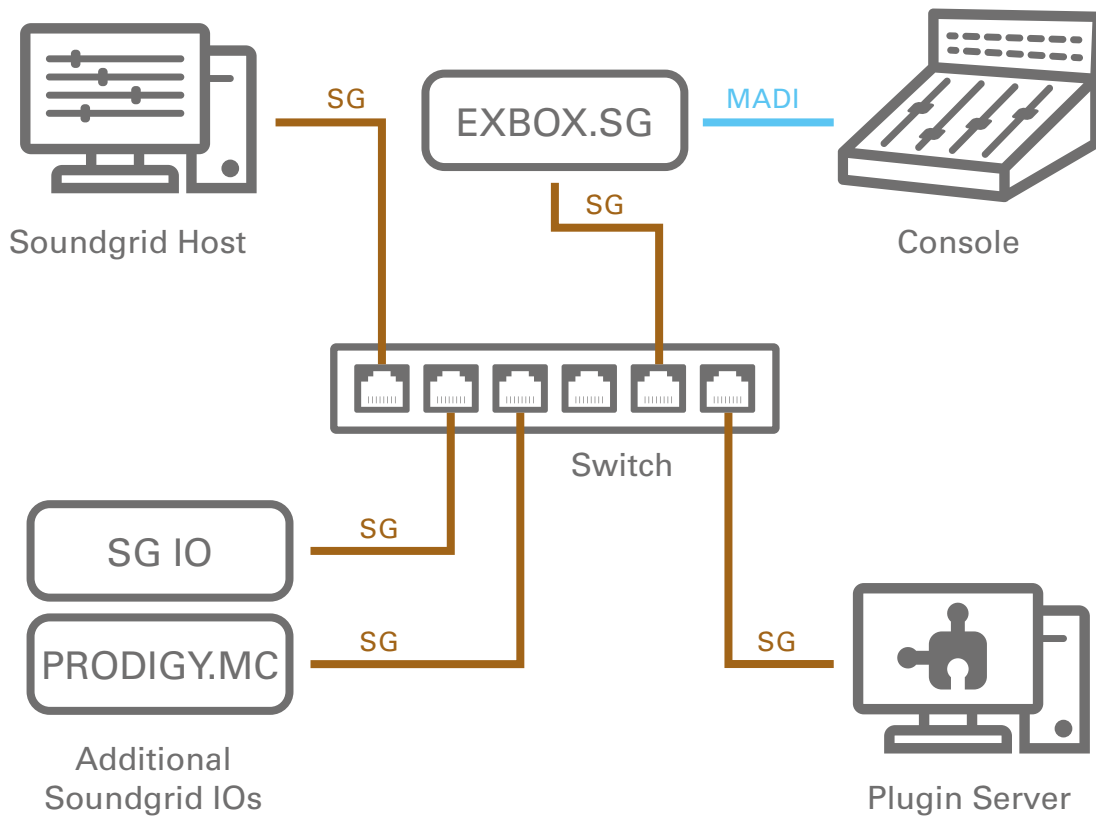

- EXBOX.SG is connected to a 1 GB ethernet switch.
- PRODIGY.MC is connected via the SG.IO module to the switch.
- All other Soundgrid devices (SG host with DAW, plugin server, SG IO) are also connected to the switch.
- Clocking: EXBOX.SG is SoE slave, clock source is a PRODIGY.MC clock source: 'SG', SG sync source 'Sync over Ethernet'

NOTE

Information about supported switches:

<https://www.waves.com/support/network-switches-for-soundgrid-systems>



Index

A		M	
Accessory		MADI formats.....	7
BOXMOUNT.XL	14		
SFP Transceiver- MADI	13	P	
Application Examples	50	PoE Class.....	45
		Power supply	7
B			
BOXMOUNT XL.....	14	R	
		Remote Control	12
C			
Channel Mode 57 ch	47	S	
Clocking		Sample rates.....	7
Options	27	Scaling Factor	23
Word Clock	29	SFP Modules	13
Conformity & Certificates		SG module state.....	31
CE	11	Signal Routing	
RoHS	11	MADI	34
WEEE	11	Soundgrid	34
Contact	11	Sketch	
Contents	12	Hirose HR10 (DC PSU)	46
Conventions.....	5	SoE	28
		Soundgrid	
D		Clocking.....	37
Defective Parts/Modules	8	Driver	33
DigiCo	47	Host.....	32
Dimensions.....	44	Master	29
Discovery Methods	22	MIDI driver.....	21
		Signal Routing.....	34
E		Support.....	42
Environmental conditions	15, 44	Sync over Ethernet	28
		Sync Settings.....	41
F			
Firmware Update.....	48	T	
First Aid	9	Technical data	44
		Troubleshooting	42
G			
globcon	12	U	
globcon control.....	12	Updates	10
I		W	
Intended Operation.....	10	Warranty	10

Waves Central	19
Word Clock	27

DirectOut GmbH

Leipziger Strasse 32
09648 Mittweida
Germany

T: +49-3727-5665-100
F: +49-3727-5665-101
www.directout.eu