

# MAVEN.A

User's Manual



## Copyright

All rights reserved. Permission to reprint or electronically reproduce any document or graphic in whole or in part for any reason is expressly prohibited, unless prior written consent is obtained from the DirectOut GmbH.

All trademarks and registered trademarks belong to their respective owners. It cannot be guaranteed that all product names, products, trademarks, requisitions, regulations, guidelines, specifications and norms are free from trade mark rights of third parties.

All entries in this document have been thoroughly checked; however no guarantee for correctness can be given.

DirectOut GmbH cannot be held responsible for any misleading or incorrect information provided throughout this manual.

DirectOut GmbH reserves the right to change specifications at any time without notice.

DirectOut Technologies® is a registered trademark of the DirectOut GmbH.

© DirectOut GmbH, 2024

---

## Table of contents

<b>About This Manual</b>	<b>7</b>
How to Use This Manual.....	7
Conventions .....	7
<b>CHAPTER 1: Overview</b>	<b>8</b>
Introduction .....	8
Feature Summary.....	9
How it works .....	10
Applications.....	10
<b>CHAPTER 2: Legal issues &amp; facts</b>	<b>12</b>
Before Installing This Device .....	12
Defective Parts/Modules .....	12
First Aid (in case of electric shock).....	13
Updates .....	14
Conditions of Warranty .....	14
Intended Operation .....	14
Conformity & Certificates .....	15
Contact.....	15
Contents.....	16
Accessories.....	17
<b>CHAPTER 3: Installation</b>	<b>22</b>
Installing the Device.....	22
<b>CHAPTER 4: Operation</b>	<b>26</b>
Introduction .....	26
Global Control.....	27
Managing Device .....	28
Networking.....	29
Slots - Connecting Audio .....	31
Slot A - Audio Network, Multi-Port MADI, USB.....	32
Slot C - Converter AD/DA, Mic, AES3.....	42
Word clock .....	54
Clocking.....	55
MADI - Single-port .....	56
USB .....	58
GPIO.....	59

<b>CHAPTER 6: Troubleshooting and Maintenance</b>	<b>60</b>
Troubleshooting.....	60
Maintenance.....	61
<b>CHAPTER 7: Technical Data</b>	<b>62</b>
<b>Index</b>	<b>68</b>
<b>Appendix A - DSUB-25 Pin assignment</b>	<b>70</b>
<b>Appendix B - DSUB-9 Pin assignment</b>	<b>71</b>
<b>Appendix C - Dimensions</b>	<b>72</b>
<b>Appendix D - System Update &amp; License Installation</b>	<b>73</b>



This page is left blank intentionally.

## About This Manual

### How to Use This Manual

This manual guides you through the installation and operation of the device. Use the Table of Contents at the beginning of the manual or Index Directory at the end of the document to locate help on a particular topic. You can access more information and latest news by visiting on the DirectOut website at [www.directout.eu](http://www.directout.eu).

### Conventions

The following symbols are used to draw your attention to:

#### **TIPS**

indicate useful hints and shortcuts.



#### **NOTES**

are used for important points of clarification or cross references.



#### **WARNINGS!**

alert you when an action should always be observed.



## CHAPTER 1: Overview

### Introduction

Welcome to MAVEN.A, DirectOut's smart platform supporting multiple formats, flexible I/O, network audio, DSP functions, sample rate conversion and powerful hard- and software.

MAVEN.A has been designed to address numerous applications in live sound, broadcast, installation and recording, and it's hardware can be configured to specific requirements.





## Feature Summary

Slot A Audio Network / Multi-port MADI Modules* USB	1 slot: - Dante (64 ch) - RAVENNA (128 ch) - SoundGrid (128 ch) - AVB / MILAN (128 ch) - MADI2 (128 ch) - BNC or SFP - MADI4 (256 ch) - USB (128 ch)
MADI (I/O)- single-port	2 x SFP (empty cage without module)
Slot C Converter Modules*	2 slots - individually configurable - 8 channels each: - Analog I/O - Line In / Out - Mic I/O - Mic In / Line Out - Digital I/O - AES3 In / Out
Headphones	1 x 6.3 mm jack & 1 x 3.5 mm jack
Word Clock (I/O):	2 x coaxial BNC (75 Ω termination switchable)
Supported Audio Network Standards (depending on module)	Dante / AES67 RAVENNA / AES67, ST 2110-30 /-31, ST 2022-7 SoundGrid AVB / MILAN
Sample Rate Conversion	FastSRC™ on MADI I/Os and Slot A I/Os HD SRC on A modules with SRC option AES4.SRC.IO modules for AES3 inputs
DSP Functions	Flex Channels with EQ, Dynamics, Delay Matrix Mixer, Summing Busses, External Insert- Points, DSP Routing
MADI Formats	56/57/64 channel, 48k/96k Frame, S/MUX
Sample Rates	44.1, 48, 88.2, 96, 176.4, 192 kHz +/-12.5%
Management Port	1 x RJ45 Socket (Gigabit-Ethernet)
Device Control	remote: via globcon or browser, Ember+, OSC local: via touch-display
GPIO	1 x DSUB-9 (2 x GPI, 2 x GPO, MOSFET switches)
USB Port	1 x USB-B port for legacy control of ANDIAMO devices 1 x USB-C port (USB 2.0)
Power Supply	This device is equipped with two wide range power supplies (84 V to 264 V AC / 47 Hz to 63 Hz / safety class 1)

\* see „Slots- Connecting Audio“ on page 31 for a comprehensive description of the different modules available.

## How it works

All modules inserted into the mainframe offer a variety of inputs and outputs that are managed by an internal routing matrix.

There are two converter slots equipped with eight channels per module and interface direction for conversion of up to 16 audio channels. Combined with the audio network/multi-port MADI option, two MADI options and the headphones outputs the maximum channel capacity of the device increases to 400 inputs and 402 outputs.

Signal processing is managed internally by a DSP routing matrix which connects hardware I/Os with the DSP processing blocks - such as Flex Channels, Matrix Mixer, Summing Busses and Plug-Ins (EQ, Delay, Dynamics).

## Applications

MAVEN.A can be used for bidirectional conversion between analog and digital signals, signal processing, signal distribution, conversion between network audio formats, streaming audio, conversion between audio networks and MADI environments, conversion of different MADI signals.

### Typical applications include:

- Live PA measurements, tuning and control
- Centralised virtual sound-check-station (collecting feeds from stage racks for multi-track recording, distribution of playback to different consoles with different formats and sample rates)
- Enhanced playback-station (with EARS)
- Signal collection and processing in broadcast and fixed installation (MicPres, EQs, Limiters, Delay, Summing Busses, Matrixes, Mixers, ...)
- Format and sample rate conversions of network audio streams
- Signal distribution (routing matrix)
- Clock extractor/distributor with automatic redundancy and selectable priorities
- Enhancing the level of redundancy of complex live and realtime audio environments
- Stream monitoring (headphones / hardware outputs)

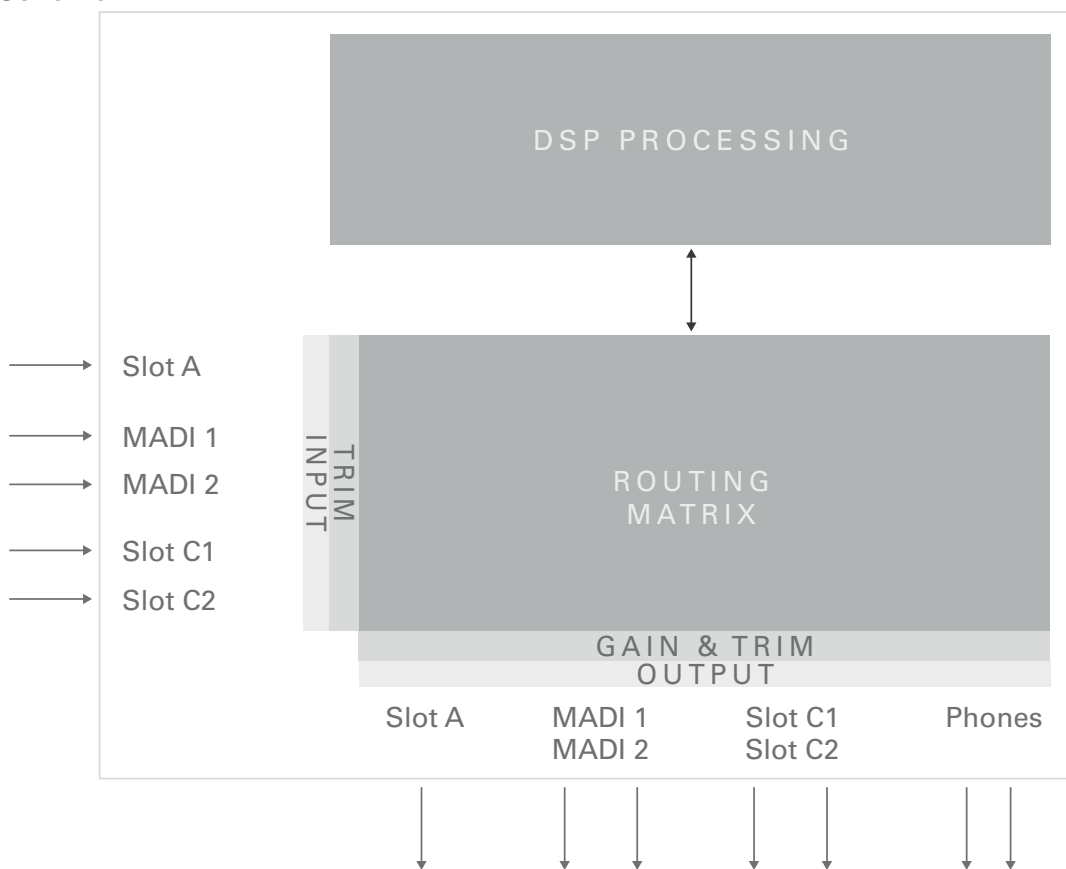
**Scheme**

## Slots:

- Slot A - Audio Network / Multi-port MADI / USB Modules
- Slot C - Converter Modules

## CHAPTER 2: Legal issues & facts

### Before Installing This Device



#### **WARNING!**

---

**Please read and observe all of the following notes before installing this product:**

- Check the hardware device for transport damage.
- Any devices showing signs of mechanical damage or damage from the spillage of liquids must not be connected to the mains supply, or disconnected from the mains immediately by pulling out the power lead.
- All devices must be grounded. The device is grounded through its IEC power connections.
- All devices must be connected to the mains using the three-cord power leads supplied with the system. Only supply electrical interfaces with the voltages and signals described in these instructions.
- Do not use the device at extreme temperatures. Proper operation can only be guaranteed between temperatures of 5° C and 45° C and a maximum relative humidity of 80 %, non-condensing.
- The cabinet of the device will heat up. Do not place the device close to heating sources (e.g. heaters). Observe the environmental conditions.

### Defective Parts/Modules



#### **WARNING!**

---

This device contains no user-serviceable parts. Therefore do not open the device. In the event of a hardware defect, please send the device to your DirectOut representative together with a detailed description of the fault. We would like to remind you to please check carefully whether the failure is caused by erroneous configuration, operation or connection before sending parts for repair.

## First Aid (in case of electric shock)

### **WARNING!**

---



- Do not touch the person or his/her clothing before power is turned off, otherwise you risk sustaining an electric shock yourself.
- Separate the person as quickly as possible from the electric power source as follows:
  - Switch off the equipment.
  - Unplug or disconnect the mains cable.
- Move the person away from the power source by using dry insulating material (such as wood or plastic).
- If the person is unconscious:
  - Check their pulse and reanimate if their respiration is poor.
  - Lay the body down and turn it to one side. Call for a doctor immediately.
- Having sustained an electric shock, always consult a doctor.

### Updates

DirectOut products are continually in development, and therefore the information in this manual may be superseded by new releases. To access the latest documentation, please visit the DirectOut website:  
[www.directout.eu](http://www.directout.eu).

This guide refers to System Build 1.

### Intended Operation

MAVEN.A is designed for signal processing / conversion / routing between analog, digital and audio network signals. Digital audio refers to AES3 and AES10, audio network refers to Dante, AVB/MILAN, SoundGrid and RAVENNA (including AES67 and SMPTE ST 2110-30 /-31).



---

### WARNING!

No compensation can be claimed for damages caused by operation of this unit other than for the intended use described above. Consecutive damages are also excluded explicitly. The general terms and conditions of business of DirectOut GmbH are applied.

### Conditions of Warranty

This unit has been designed and examined carefully by the manufacturer and complies with actual norms and directives.

Warranty is granted by DirectOut GmbH over the period of 36 months for all components that are essential for proper and intended operation of the device. The date of purchase is applied for this period.

Consumable parts (e.g. battery) are excluded from warranty claims.



---

### WARNING!

All claims of warranty will expire once the device has been opened or modified, or if instructions and warnings were ignored.

For warranty claims please contact the dealer where your device was acquired.

## Conformity & Certificates

### CE

This device complies with the basic requests of applicable EU guidelines. The appropriate procedure for approval has been carried out.

### RoHS

(Restriction of the use of certain Hazardous Substances)

This device was constructed fulfilling the directive on the restriction of the use of certain hazardous substances in electrical and electronic equipment 2011/65/EU and 2015/863.

### WEEE

(Directive on Waste Electrical and Electronic Equipment)

Due to the directive 2002/96/EC for waste disposal this device must be recycled.

For correct recycling please dispatch the device to:

DirectOut GmbH,  
Hainichener Str. 66a  
09648 Mittweida  
Germany

Only stamped parcels will be accepted!

WEEE-Reg.-No. DE 64879540

### Contact

DirectOut GmbH  
Hainichener Str. 66a, 09648 Mittweida, Germany  
Phone: +49 (0)3727 5650-00  
Mail: [sales@directout.eu](mailto:sales@directout.eu)  
[www.directout.eu](http://www.directout.eu)

## Contents

The contents of your MAVEN.A package should include:

- 1 x MAVEN.A (19", 1 RU)
- 2 x power chord with self locking mechanism

The device provides slots for audio network modules, MADI modules and converter modules. The modules may be delivered separately and require installation first to complete the delivery.



## TIP

Keep any packaging in order to protect the device should it need to be dispatched for service.

## Remote Control

To access all functions of the device it is required to install the globcon remote control.

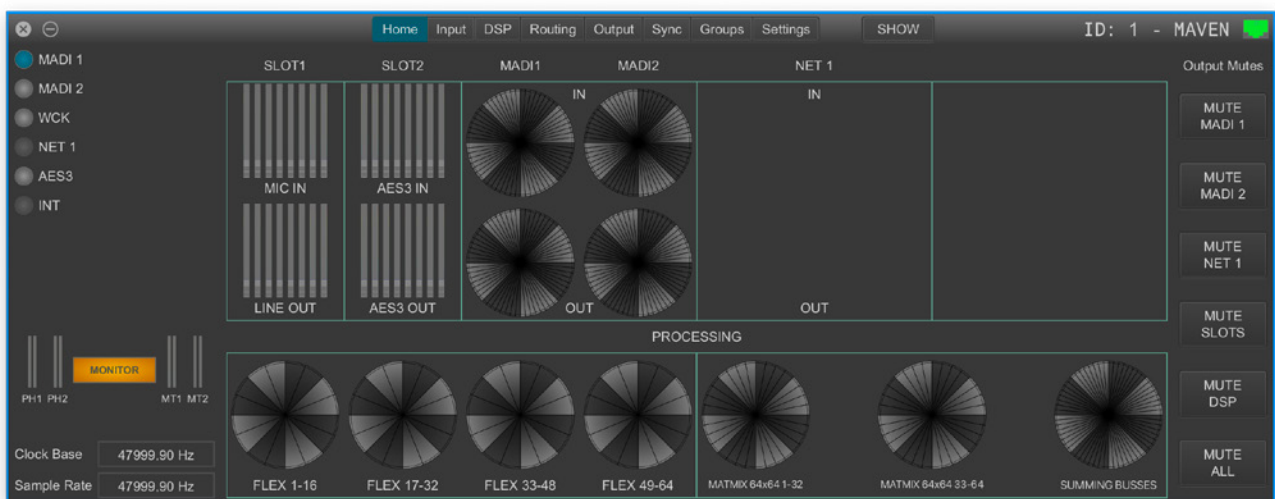

globcon is a free, global control software platform for the management of professional audio equipment. Almost all products of the DirectOut product portfolio are supported by globcon.

Link: [www.globcon.pro](http://www.globcon.pro)



## Accessories

### BREAKOUT

The BREAKOUT series is a range of adaptor boxes available in different variants to extend the coverage of the ANDIAMO, MAVEN and PRODIGY series. They are equipped with XLR or BNC connectors on the front panel and DSUB-25 connectors on the rear panel. Audio signals are carried passively between the front and rear panels.

The small form factor and angle brackets also allow for mounting the devices on the back of an ANDIAMO or MAVEN or PRODIGY unit.



BREAKOUT.AN8 - analog input / output, 8 channels

Article code: DOBOB0889



BREAKOUT.AN16I - analog input, 16 channels

Article code: DOBOB0890



BREAKOUT.AN16O - analog output, 16 channels



BREAKOUT.AES - digital input / output, 8 AES3 ports (16 channels)  
Article Code: DOBOB0887



BREAKOUT.AESID - digital input / output, 16 AESid ports (32 channels)  
Article Code: DOBOB0888

**Patch Chords**

Cabling from Cordial provides appropriate connection of the BREAKOUT with your device to ensure proper transmission of the audio signals.

Name	Description	Article code
DSUB25.AN50	Analog patch cable for connection with BREAKOUT.AN16I, AN16O, AN8, transferring 8 audio channels, length 0.5 m	DOCAA0334
DSUB25.AN100	Analog patch cable for connection with BREAKOUT.AN16I, AN16O, AN8, transferring 8 audio channels, length 1.0 m	DOCAA0335
DSUB25.AES50	Digital patch cable for connection with BREAKOUT.AES or AESid transferring 8 audio channels, length 0.5 m	DOCAA0332
DSUB25.AES100	Digital patch cable for connection with BREAKOUT.AES or AESid transferring 8 audio channels, length 0.5 m	DOCAA0333

## SFP Transceiver - MAD1

Two different optical SFP transceiver for MAD1 transmission are available from DirectOut GmbH:

- Multimode SFP transceiver with LC connectors (No: DOICT0129)
- Singlemode SFP transceiver with LC connectors (No: DOICT0130)

### Specification of the optical SFP transceivers:

SFP	Multimode	Singlemode
Wavelength TX nominal	1310 nm	1310 nm
Wavelength RX nominal	1310 nm	1310 nm
Distance	2 km	10 km
Powerbudget (dB)	> 11 dB	> 12 dB
Protocols	Fast Ethernet OC3/STM1	Gigabit Ethernet, Gigabit Fibre Channel
Bandwidth from	100 Mbit/s	1.050 Gbit/s
Bandwidth	155 Mbit/s	1.250 Gbit/s
Laser	FP	FP
Receiver Type	PIN	PIN
Connector	LC	LC
Wavelength TX min	1260 nm	1260 nm
Wavelength TX max	1360 nm	1360 nm
Wavelength RX min	1260 nm	1260 nm
Wavelength RX max	1620 nm	1600 nm
Transmit min	- 19.00 dBm	- 9.00 dBm
Transmit max	- 14.00 dBm	- 3.00 dBm
Receive min	- 30 dBm	- 21.00 dBm
Receive max (Receiver overload)	- 5.00 dBm	- 3.00 dBm
Temperature (min)	0° Celsius	0° Celsius
Temperature (max)	70° Celsius	70° Celsius
Type of DDM/DOM	internal	internal
Extinction Ratio	8.20 dB	9 dB

**SFP Transceiver - Network**

Two different optical SFP transceiver for 1Gbit/s ethernet transmission are available from DirectOut GmbH:

- SFP Copper Transceiver, RJ-45 (No: DOICT0132)
- SFP Optical Transceiver, optical LC Single Mode (No: DOICT0133)

**Specification**

SFP	Copper - RJ45	Optical - LC single mode
Distance	100 m via CATe cable	2000 m
Wavelength	-	1310 nm
Datarate	12 Mbit/s to 1.25 Gbit/s	2.67 GBit/s

This page is left blank intentionally.

## CHAPTER 3: Installation

### Installing the Device

1. Open the packaging and check that the contents have been delivered complete and undamaged.
2. Fix the device in a 19" frame with four screws, or place it on a non-slip horizontal surface.



### WARNING!

Avoid damage from condensation by waiting for the device to adapt to the environmental temperature. Proper operation can only be guaranteed between temperatures of 5° C and 45° C and a maximum relative humidity of 80%, non-condensing.

Ensure that the unit has sufficient air circulation for cooling.

Do not cover the fan outlets and the slots at the sides of the device!

Do not block the fans by putting objects through the protective grid!



3. For installation of separately delivered modules follow the instructions in the manual enclosed with the packaging of the modules.



<b>1</b>	A Slots - see page 32
<b>2</b>	C Slots - see page 42

4. Connect the signal cables with the installed modules. For more details about connecting audio network, MADI, AES3 and analog signals see „Slots- Connecting Audio“ on page 31.
5. Connect a network cable to the socket 'MGMT' to control the device via network.



6. Using the power cord provided connect the PSUs to a matching power supply.



The delivered power cords provide a self-locking mechanism to prevent an accidental disconnect. To unlock the connection press the red release mechanism.



## **WARNING!**

This device must be connected to the mains using the three-core power leads supplied with the system. Only supply the voltages and signals indicated (84 V – 264 V).



**7.** Turn on the power switches:



Check the display on the front panel for warnings.

**8.** Enter `http://<IP Address>` (default IP: DHCP) in the navigation bar of your browser to open the control website. The IP address is assigned by the DHCP server of your network and can be checked or altered on the display at the front panel.

**9.** Install globcon on your computer  
To access all functions the use of globcon is required - see page 16.

**10.** Launch globcon control  
Select the port of the network where your device is connected to  
Sidebar - My Devices - Click Discovery Methods  
and set Ethernet Discovery to 'ON'

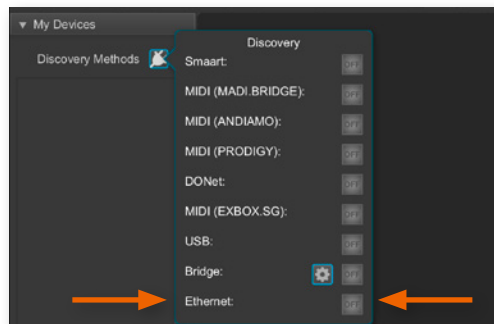

Select the device from the list and click 'Add'

Type	IP	Name
MAVEN	192.168.72.37	MAVEN



Confirm your selection with 'OK'

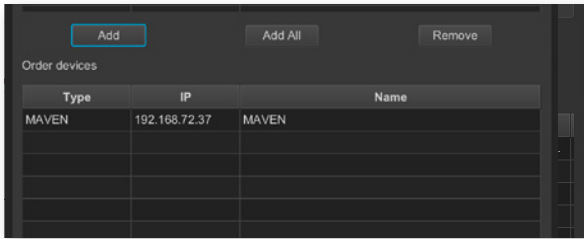

The device is displayed in the overview of globcon  
Double-Click the tiny display of the device to open the control.



More information and video tutorials about globcon are available  
at [www.globcon.pro](http://www.globcon.pro).

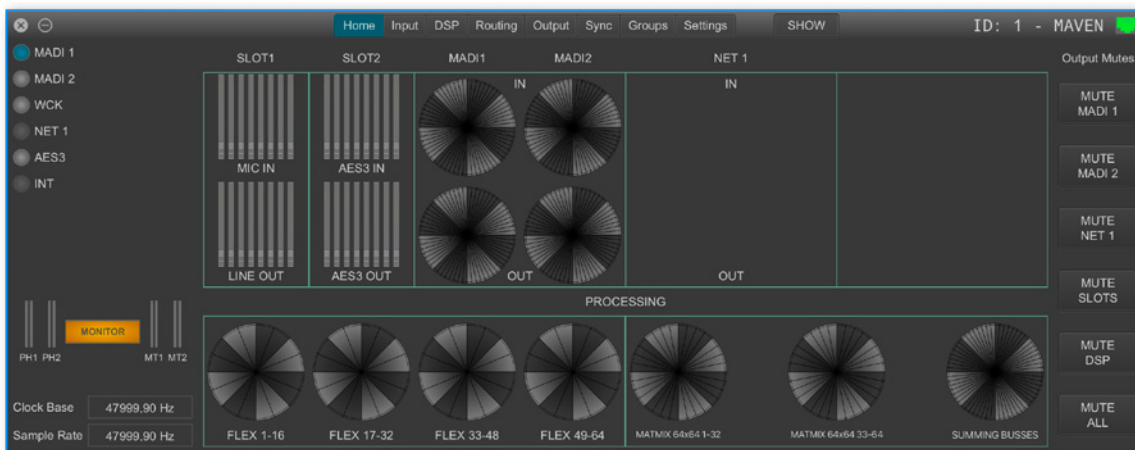

## NOTE



For globcon control of the device the network infrastructure is required to have ports 5002, 5003 and 5004 unfiltered for TCP traffic.  
Since the device discovery uses multicast-DNS (mDNS), the device may be discovered but cannot be controlled if the ports 5002, 5003 and 5004 are filtered.

## CHAPTER 4: Operation

### Introduction

This chapter describes the basic operation of the device.

Note that throughout this manual, the abbreviation FS refers to sample rate or sample frequency. So, when dealing with scaling factors, the following sample rates can be written as:

- 44.1 kHz or 48 kHz = 1 FS
- 88.2 kHz or 96 kHz = 2 FS
- 176.4 kHz or 192 kHz = 4 FS

## Global Control

The display on the front panel indicates the power supply. The power switches are on the back panel:



PSU 1 & PSU 2	<b>2 Switches</b> Enable / disable power supply.
PSU 1 & PSU 2	<b>2 C13 sockets</b> Connect the power supply here (84- 264 V AC).

## WARNING



Before switching off the power supply, the system must be shut down first.



<b>POWER</b> PSU 1 & PSU 2	<b>LED RGB - indicates state of power supply</b> <ul style="list-style-type: none"> <li>○ (OFF) = power supply not working</li> <li>● (ON, green) = power supply working</li> <li>⦿ (blinking, red) = power supply was active and is now inactive.</li> </ul>
-------------------------------	--

## NOTE



The green LEDs (PSU 1 & PSU 2) indicate that a working power supply is connected to the power supply unit. Note that an unlit LED does not guarantee that the device is free of voltage. To ensure that the device is completely disconnected from mains voltage, the power chords must be disconnected.

### Managing Device

The device is equipped with a touch-display, an encoder and two push buttons for local control. For remote operation a network socket is provided at the rear panel to operate the device via a browser based GUI or via globcon.







MENU	<b>Push-button to access the MENU.</b> Press shortly to call the top menu.
BACK	<b>Push-button to return to previous page.</b> Press shortly to return to the previous page.
Display	<b>Touch-Display to navigate the menu, adjust settings and for monitoring.</b> tap, swipe- have fun!
CONTROL	<b>Encoder to adjust values and confirmation.</b> Rotate to modify values. Press to confirm a setting.

## Networking

MAVEN.A uses separate network links for managing the device and audio network transmission.



MGMT <b>1</b>	<b>1 x RJ 45 socket</b> Connect here for network control and firmware updates.
MGMT	<b>LED orange - indicates the link state of the network connection.</b>  (ON) = device link active  (OFF) = device link not active
MGMT	<b>LED green - indicates the activity state of the network connection.</b>  (ON) = data sent or received  (OFF) = no data transmission
SLOT A <b>2</b>	<b>Option Slot for audio network or multi-port MADI or USB modules</b> See „Slot A- Audio Network, Multi-Port MADI, USB“ on page 32

This page is left blank intentionally.

## Slots - Connecting Audio

MAVEN.A offers two different slot-types that can be populated individually according to particular requirements. Further two SFP sockets can be equipped with suited transceivers to offer two single MADI I/O ports (see „SFP Transceiver-MADI“ on page 19).



Slot A <b>1</b>	<b>1 x Option slot for audio network or multi-port MADI or USB modules</b> See „Slot A- Audio Network, Multi-Port MADI, USB“ on page 32
Slot C <b>2</b>	<b>2 x Option slot for Converter Modules</b> See „Slot C- Converter AD/DA, Mic, AES3“ on page 42

## **WARNING!**



All module slots must be fitted with a module or a blind plate each. Otherwise live parts become accessible which may cause serious harm to your health. An open housing may also cause inappropriate operation conditions due to an insufficient electromagnetic shielding.

## Slot A - Audio Network, Multi-Port MADI, USB

Modules for A Slots connect with different audio networks or MADI or USB. Four audio network protocols (Dante, RAVENNA, SoundGrid, AVB/MILAN) are supported. The multi-port MADI modules are available in variants with two or four MADI ports (see p 38). The USB.IO module interfaces with computer-based production systems (see p 40).

### Audio Network

Each module is equipped with 1 x SFP and 2 x RJ45-sockets (Gigabit-Ethernet).

Module	Protocol	Capacity	SRC*
DANTE.IO	Dante / AES67	64 ch in / out	no <input type="checkbox"/> SRC
DANTE.SRC.IO	Dante / AES67	64 ch in / out	yes <input checked="" type="checkbox"/> SRC
RAV.IO	RAVENNA / AES67 / SMPTE ST 2110-30 /-31	128 ch in / out	no <input type="checkbox"/> SRC
RAV.SRC.IO	RAVENNA / AES67 / SMPTE ST 2110-30 /-31	128 ch in / out	yes <input checked="" type="checkbox"/> SRC
SG.IO	SoundGrid	128 ch in / out	no <input type="checkbox"/> SRC
SG.SRC.IO	SoundGrid	128 ch in / out	yes <input checked="" type="checkbox"/> SRC
MILAN.IO	AVB / MILAN	128 ch in / out	no <input type="checkbox"/> SRC
MILAN.SRC.IO	AVB / MILAN	128 ch in / out	yes <input checked="" type="checkbox"/> SRC

\* The SRC versions are equipped with a bidirectional sample rate converter (HD SRC).

They are marked with a dot on the module plane.

**DANTE.IO**  
**DANTE.SRC.IO**

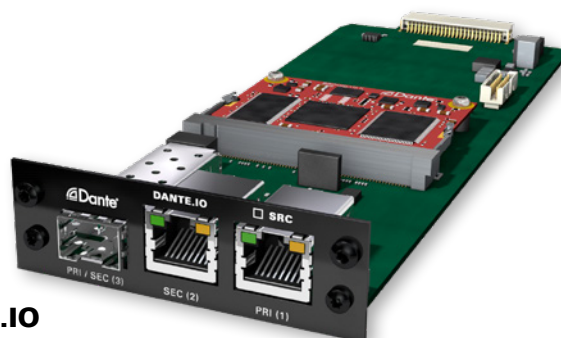



---

**RAV.IO**  
**RAV.SRC.IO**

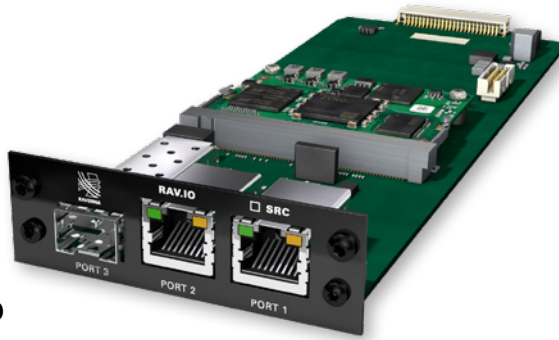

**SG.IO**  
**SG.SRC.IO**

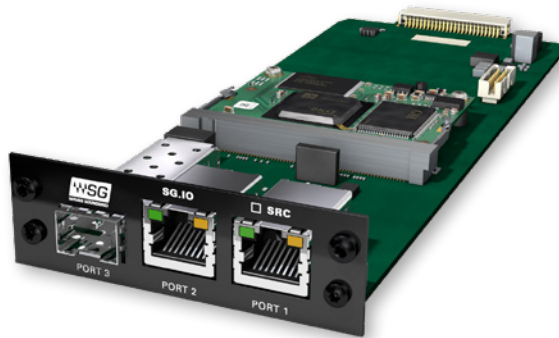

**MILAN.IO**  
**MILAN.SRC.IO**

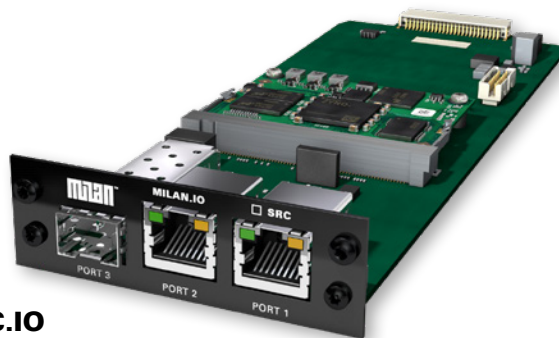



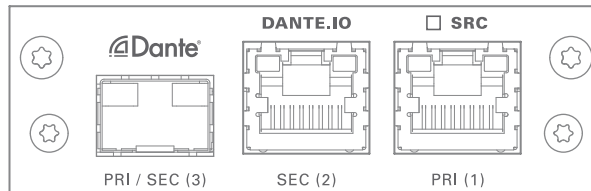

### DANTE.IO / DANTE.SRC.IO

Three network ports are available for transmission of audio signals (Dante / AES67). The built-in network switch can be operated in three modes:

- Switched (all ports in the same network)
- Redundant (1 = Primary, 2 = Secondary, 3 = Primary)
- Red\_Sec (1 = Primary, 2 & 3 = Secondary)



The switch will be configured automatically by selecting the respective operation mode in Dante Controller.

PRI (1)	<b>RJ45 socket (1 Gbit/s)</b> Network interface - connect here for network transmission. Primary Port when used in redundant operation.
SEC (2)	<b>RJ45 socket (1 Gbit/s)</b> Network interface - connect here for network transmission. Secondary Port when used in redundant operation.
PRI (1) SEC (2)	<b>LED orange - indicates the link state of the network connection.</b>  (ON) = device link active  (OFF) = device link not active
PRI (1) SEC (2)	<b>LED green - indicates the activity state of the network connection.</b>  (ON) = data sent or received  (OFF) = no data transmission
PRI / SEC (3)	<b>SFP cage</b> Insert SFP transceiver here and connect to the network.* Primary or secondary (selectable) port when used in redundant operation.

\* See page 20 for SFP-transceiver that are available by DirectOut.



### NOTE

If redundancy is being used, secondary interfaces should be connected to a second separate network. Secondary interfaces cannot communicate with primary interfaces.

---

## RAV.IO / RAV.SRC.IO

Three network ports are available for transmission of audio signals (RAVENNA / AES 67 / SMPTE 2110-30 / -31). The module supports Seamless Protection Switching according to SMPTE 2022-7.

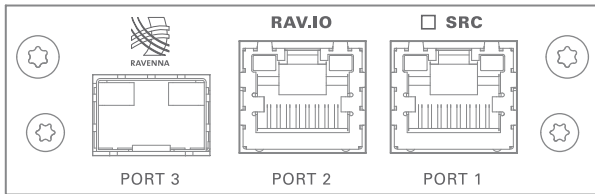

PORT 1 PORT 2	<b>RJ45 socket (1 Gbit/s)</b> Network interface - connect here for network transmission.
PORT 1 PORT 2	<b>LED orange - indicates the link state of the network connection.</b> ■ (ON) = device link active ■ (OFF) = device link not active
PORT 1 PORT 2	<b>LED green - indicates the activity state of the network connection.</b> ■ (ON) = data sent or received ■ (OFF) = no data transmission
PORT 3	<b>SFP cage</b> Insert SFP transceiver here and connect to the network.*

\* See page 20 for SFP-transceiver that are available by DirectOut.

The configuration of the built-in network switch is available via the browser interface of the RAV.IO-module.

## NOTE





Further devices that require PTP synchronisation should be connected to an external PTP-aware switch.

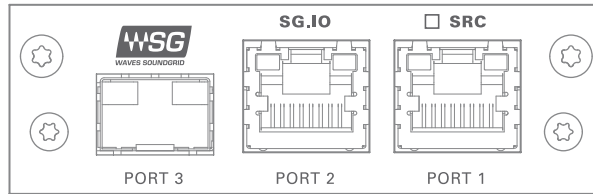

**SG.IO / SG.SRC.IO**

Three network ports are available for transmission of audio signals (SoundGrid).







PORT 1 PORT 2	<b>RJ45 socket (1 Gbit/s)</b> Network interface - connect here for network transmission.
PORT 1 PORT 2	<b>LED orange - indicates the link state of the network connection.</b>  (ON) = device link active  (OFF) = device link not active
PORT 1 PORT 2	<b>LED green - indicates the activity state of the network connection.</b>  (ON) = data sent or received  (OFF) = no data transmission
PORT 3	<b>SFP cage</b> Insert SFP transceiver here and connect to the network.*

\* See page 20 for SFP-transceiver that are available by DirectOut.

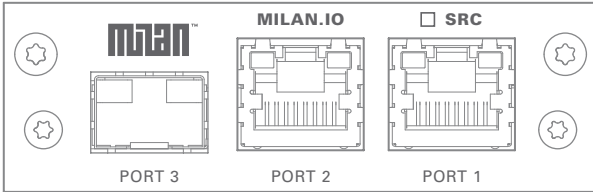
## MILAN.IO / MILAN.SRC.IO

Three network ports are available for transmission of audio signals (AVB / MILAN).



PORT 1 PORT 2	<b>RJ45 socket (1 Gbit/s)</b> Network interface - connect here for network transmission.
PORT 1 PORT 2	<b>LED orange - indicates the link state of the network connection.</b>  (ON) = device link active  (OFF) = device link not active
PORT 1 PORT 2	<b>LED green - indicates the activity state of the network connection.</b>  (ON) = data sent or received  (OFF) = no data transmission
PORT 3	<b>SFP cage</b> Insert SFP transceiver here and connect to the network.*

\* See page 20 for SFP-transceiver that are available by DirectOut.

The configuration of the built-in network switch is available via the browser interface of the RAV.IO-module.

**Multi-port MADI**

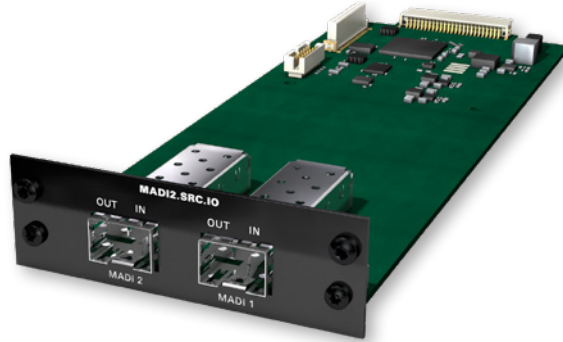

**MADI2.SRC.IO**



**MADI2.BNC.SRC.IO**

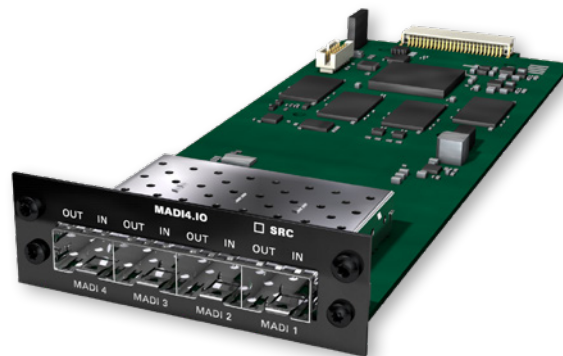

**MADI4.IO**  
**MADI4.SRC.IO**  
(PRODIGY.MX, MAVEN.A only)

## MADI2.SRC.IO

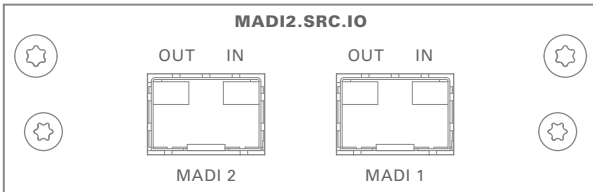

SFP	<p><b>2 x SFP cage</b>          Insert SFP transceiver(s) here and connect MADI input/output.</p>
-----	---

## MADI2.BNC.SRC.IO

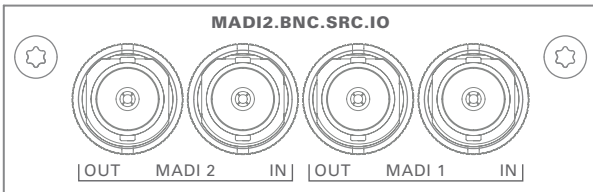

BNC	<p><b>2 x BNC socket (coaxial)*</b>          OUT: MADI output, connect for MADI output signal here.          IN: MADI input, connect MADI input signal here</p>
-----	---

## MADI4.IO / MADI4.SRC.IO (PRODIGY.MX, MAVEN.A only)

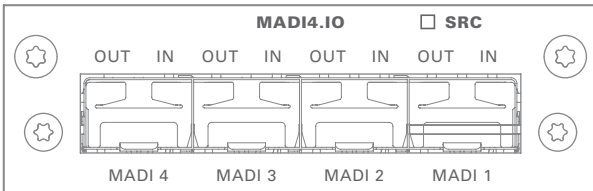

SFP	<p><b>4 x SFP cage</b>          Insert SFP transceiver(s) here and connect MADI input/output.</p>
-----	---

**USB Audio**



**USB.IO**



## USB.IO

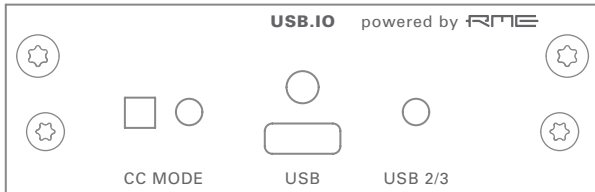

USB	<b>1 x USB-C socket for audio transmission</b> Connect with USB 3.0 or 2.0 port
CC MODE	<b>Push button</b> Press to toggle operating mode. Restart of the module or dis- / reconnect of the USB connection is required after change.
CC MODE	<b>LED orange - indicates operation mode</b> ○ (OFF) = CC mode OFF ● (ON, orange) = CC mode ON
USB	<b>USB-C socket for audio transmission</b> Connect with USB 3.0 or 2.0 port
USB 2/3	<b>LED RGB - indicates USB connection</b> ● (ON, blue) = USB 3.0 (128 channels) ● (ON, yellow) = USB 2.0 (64 channels) ● (ON, red) = no USB connection

### Slot C - Converter AD/DA, Mic, AES3

The C Slots can be equipped with analog or digital modules. The pin-out of the DSUB-25 sockets is according to AES59 ('Tascam').

#### Analog Modules

Module	Input	Output
AN8.O		8 ch line out
AN8.IO	8 ch line in	8 ch line out
AN8.I	8 ch line in	
MIC8.HD.I	8 ch mic input (HD)	
MIC8.HD.IO	8 ch mic input (HD)	8 ch line out
MIC8.LINE.IO	8 ch mic input	8 ch line out
MIC8.LINE.I	8 ch mic input	

**AN8.O**



**AN8.IO**



---

**AN8.I**



**MIC8.HD.I**



**MIC8.HD.IO**



**MIC8.LINE.IO**

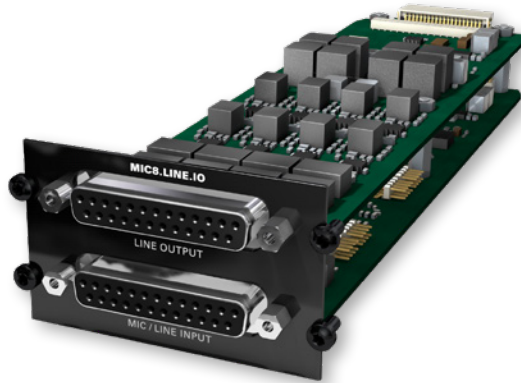

**MIC8.LINE.I**



---

## Reference Level

The analog reference level of line inputs and outputs can be adjusted via jumper - for each channel individually. Check the label on the particular board. At modules with two boards the input is at the bottom and the pins are accessed from the side, where as the output is at the top and the pins are accessed from the top.

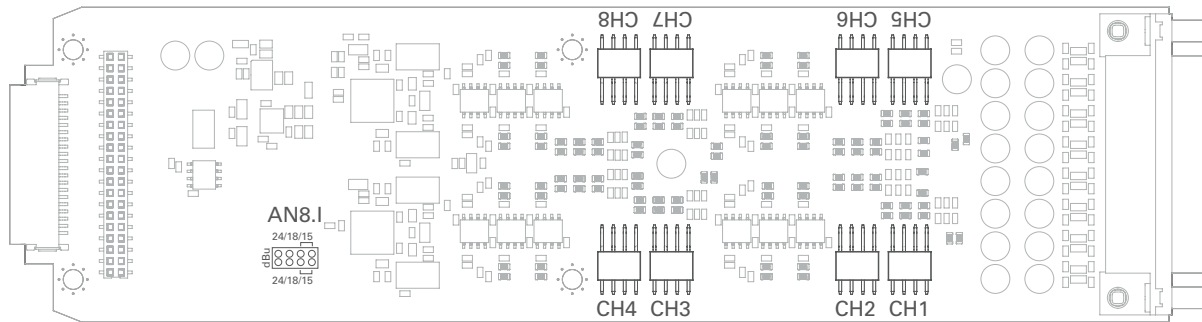

AN8.I - access from sideways

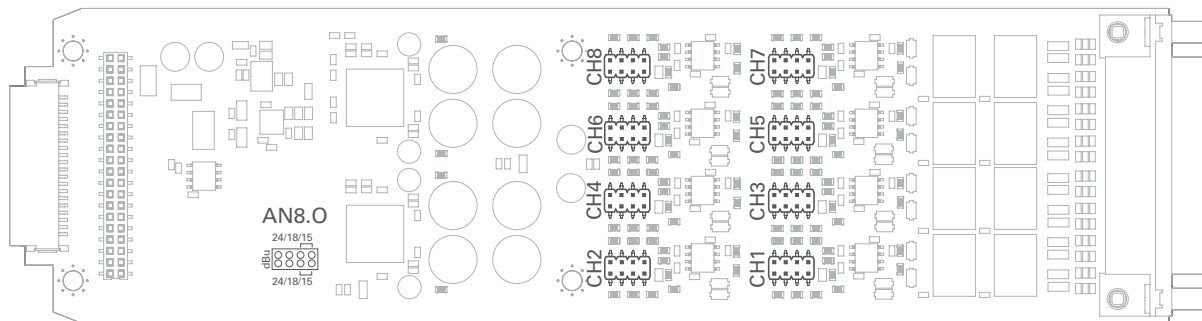

AN8.O - access from top

**Level Settings**

15 dBu

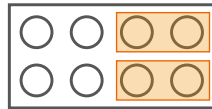

18 dBu

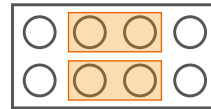

24 dBu

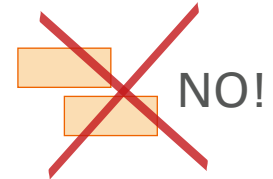
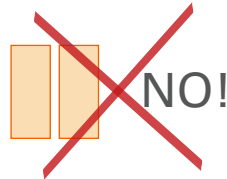
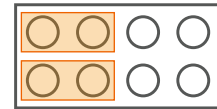

**WARNING**

---

To prevent damage from the board only set the jumpers parallel in horizontal direction - as illustrated above.



**NOTE**

---

The pinout of the digital and analog I/O is different. Check for appropriate cabling to ensure proper operation and to avoid damages caused by improper connections.

The analog outputs are fed by the D/A converters and not a split-out of the analog inputs.



**WARNING**

---

Do not connect voltage sources to the analog outputs. This may cause damage at the output stages. Observe the technical specifications listed in this document.



**WARNING**

---

The line output is not servo balanced. Do not connect the negative lead to ground. This may cause damage at the output stage. Observe the technical specifications listed in this document.

---

## AN8.O

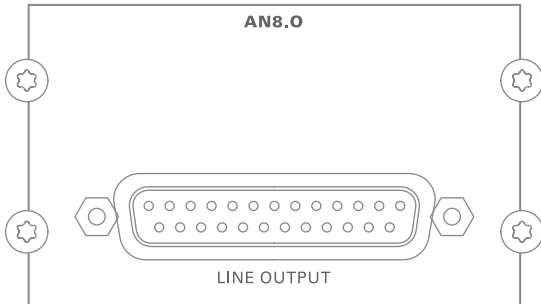

LINE OUTPUT	<b>DSUB-25 Port (analog pinout)</b> Analog audio output (balanced) - connect for line level audio here
-------------	--

## AN8.IO

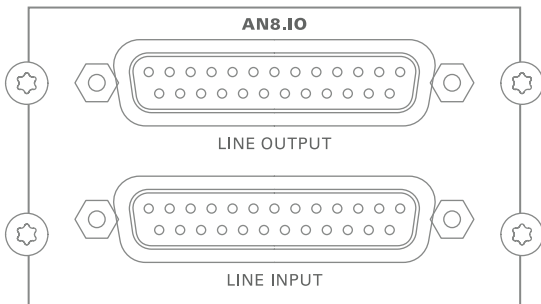

LINE OUTPUT	<b>DSUB-25 Port (analog pinout)</b> Analog audio output (balanced) - connect for line level audio here
LINE INPUT	<b>DSUB-25 Port (analog pinout)</b> Analog audio input (balanced) - connect line level audio source here

The pinout complies with AES59 ('TASCAM pinout') - see „Appendix A- DSUB-25 Pin assignment“ on page 70.

**AN8.I**

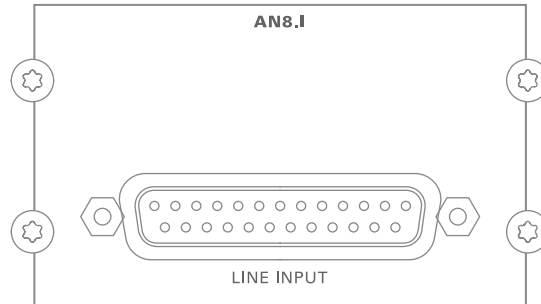

LINE INPUT	<p><b>DSUB-25 Port (analog pinout)</b> Analog audio input (balanced) - connect line level audio source here</p>
------------	---

**MIC8.HD.I**

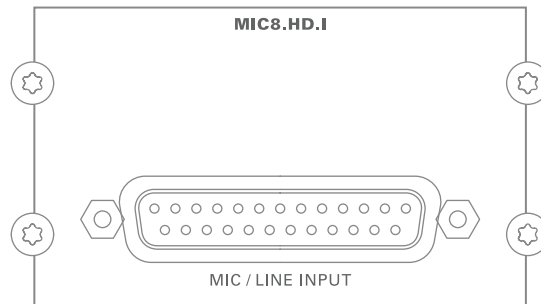

MIC / LINE INPUT	<p><b>DSUB-25 Port (analog pinout)</b> Analog audio input (balanced) - connect mic / line level audio source here</p>
------------------	---

The pinout complies with AES59 ('TASCAM pinout') - see „Appendix A- DSUB-25 Pin assignment“ on page 70.



## MIC8.HD.IO

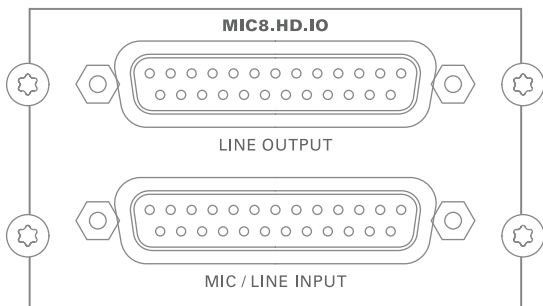

LINE OUTPUT	<b>DSUB-25 Port (analog pinout)</b> Analog audio output (balanced) - connect for line level audio here
MIC / LINE INPUT	<b>DSUB-25 Port (analog pinout)</b> Analog audio input (balanced) - connect mic / line level audio source here

## MIC8.LINE.IO

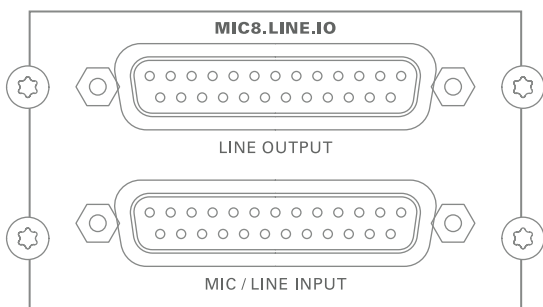

LINE OUTPUT	<b>DSUB-25 Port (analog pinout)</b> Analog audio output (balanced) - connect for line level audio here
MIC / LINE INPUT	<b>DSUB-25 Port (analog pinout)</b> Analog audio input (balanced) - connect mic / line level audio source here

The pinout complies with AES59 ('TASCAM pinout') - see „Appendix A- DSUB-25 Pin assignment“ on page 70.

**MIC8.LINE.I**

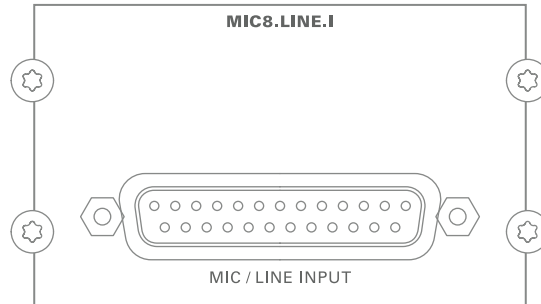

MIC / LINE INPUT	<b>DSUB-25 Port (analog pinout)</b> Analog audio input (balanced) - connect mic / line level audio source here
------------------	--

The pinout complies with AES59 ('TASCAM pinout') - see „Appendix A- DSUB-25 Pin assignment“ on page 70.

---

## Digital Modules

Module	Input	Output
AES4.IO	4 port AES3 in	4 port AES3 out
AES4.SRC.IO	4 port AES3 in with SRC	4 port AES3 out

### AES4.IO



### AES4.SRC.IO



## NOTE

An AES4.IO transports eight audio channels - two audio channels per port.



**AES4.IO**

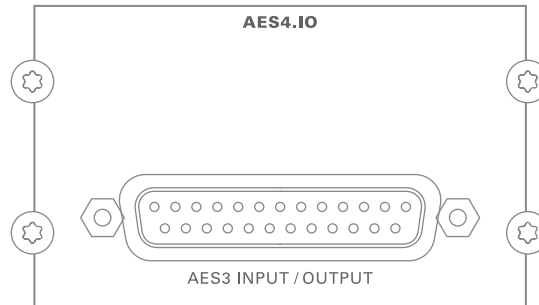

AES3 INPUT / OUTPUT	<p><b>DSUB-25 Port (digital pinout)</b> Digital audio input and output (AES3) - connect for digital audio here</p>
---------------------	--

**AES4.SRC.IO**

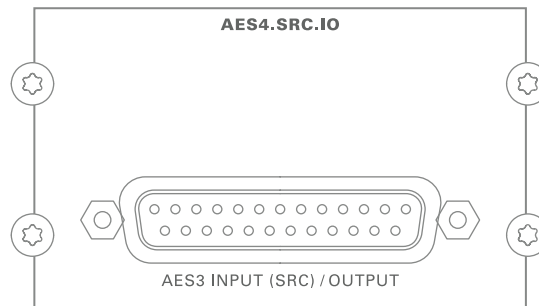

AES3 INPUT (SRC) / OUTPUT	<p><b>DSUB-25 Port (digital pinout)</b> Digital audio input and output (AES3) - connect for digital audio here. Input offers switchable Sample Rate Conversion.</p>
---------------------------	---

The pinout complies with AES59 ('TASCAM pinout') - see „Appendix A- DSUB-25 Pin assignment“ on page 70.

---

This page is left blank intentionally.

## Word clock

The word clock output provides the system clock that is either derived from PTP / Network Audio input, AES input, word clock input, MADI input or internal clock generator.



WCK OUT	<b>BNC socket (coaxial), 75 Ω</b> System clock output - connect for word clock output signal here.
WCK IN	<b>BNC socket (coaxial), 75 Ω</b> Connect word clock or AES3 DARS (Digital Audio Reference Signal) here.

Both word clock inputs also accept a AES3 frame (AES11).

Termination (75 Ω) for the word clock inputs is switchable locally or via remote control.

## Clocking

The device offers several options for clocking.

- PTP (Precision Time Protocol) - IEEE1588-2008 / PTPv 1 & 2 \*
- SoundGrid (SoE) \*
- AVB \*
- Word Clock / Video
- MADI input \*
- AES3 input \*
- internal clock generator

\* depending on the modules installed.

When PTP (network) is selected the device can either act as slave or as network grandmaster.

The front panel informs about selected clock sources and their lock / sync state.



<p><b>SYNC</b></p> <p>AES 1</p> <p>AES 2</p> <p>NET*</p> <p>MADI 1</p> <p>MADI 2</p>	<p><b>LED RGB - indicates the lock / sync state of MADI input, Network-clock or AES3 input.</b></p> <p>○ (OFF) = no signal lock</p> <p>● (ON, green) = signal lock, in sync</p> <p>● (ON, blue) = signal lock, in sync, selected clock source</p> <p>● (ON, yellow) = signal lock, sample rate conversion active</p> <p>● (blinking, green) = signal lock, not in sync with selected clock source</p> <p>● (blinking, red) = input selected as clock source and no signal lock.</p>
--	---

\* depending on the module in 'Slot A', which allows to be populated with audio network or multi-port MADI or USB modules.

### MADI - Single-port

The MADI ports are used for transmission of 64 audio channels (AES10).  
Two SFP ports offer individual I/O configurations. \*



MADI 1/2	<p><b>SFP cage</b></p> <p>Insert SFP transceiver here and connect MADI input/output.</p>
----------	--

\* matching SFP transceiver are available from DirectOut - see p 19.



### NOTE

For more MADI I/Os, slot A can be populated with multi-port MADI modules - see "Multi-port MADI Modules" on page 38. These modules are offered also with bi-directional sample rate conversion (HD-SRC).



---

This page is left blank intentionally.

## USB

Two USB ports at the front and rear panel are used for legacy control of ANDIAMO devices via globcon bridge.



<b>USB</b> (front)	<b>USB 2.0 socket (Type A)</b> Connect here for legacy control.
<b>USB</b> (rear)	<b>USB 2.0 socket (Type C)</b> Connect here for legacy control. This socket offers top-screw locking.



## NOTE

The local USB ports are not used for audio transmission. To interface with an USB audio transmission the Slot A needs to be populated with an USB.IO module - see „USB.IO“ on page 41.

---

## GPIO

General Purpose Input and Output

Two MOSFET switches (2 x GPO) can be triggered. A power supply (12 V, max. 200 mA) is also provided. This allows to remote control external devices; e.g. a recording light.

Two GPIOs can be triggered by connecting the input pin with ground (GND) or by a voltage source between input pin and ground. The high level of the voltage may range between 2 V and 30 V due to a safety limiter in the input.



GPIO

**DSUB-9 socket (female)**

Connect for GPIO application here.

Observe the pin out - see „Appendix B- DSUB-9 Pin assignment“ on page 71.

## CHAPTER 6: Troubleshooting and Maintenance

### Troubleshooting

To identify a possible defect with the device please consult the following table. If the fault cannot be resolved using these instructions, please contact your local DirectOut representative or visit [support.directout.eu](http://support.directout.eu).

Issue	Possible reason	Solution
Device doesn't work.	Power supply is broken.	Check that the power supply switch is on, that the device is connected to the power supply and that the socket is working. Defective fuses must be exchanged by qualified service personal only.
Optical port does not work.	Optic is dirty.	Use an air supply to carefully remove any dust. Never use objects for cleaning.
No signal at the output port.	Connections (input / output) are mixed up.	Check the connections and change the cables if necessary. Check the routing matrix.
No signal at the output port.	Signal cable defective.	Exchange the signal cable.
MADI signal at the input is not stable.	Signal source is defective or bad signal condition (Jitter > 1 ns)- e.g. due to exceeded length or bad screening attenuation of signal cable.	Change the source or use appropriate cables.
Clicks in the audiosignal.	Input source is not in sync with clock master of the box.	Check the status of input LED and check clock setting of the connected device.

---

## Maintenance

To clean the device, use a soft, dry cloth. To protect the surface, avoid using cleaning agents.

### **NOTE!**



The device should be disconnected from the power supply during the cleaning process.

## CHAPTER 7: Technical Data

### Dimensions (sketch on page 72)

- Width 19" (483 mm)
- Height 1 RU (44.5 mm)
- Depth 10" (254 mm)
- Weight about 8 kg

### Power Consumption

- 20 W to 55 W, module dependent

### Power Supply

- 2 x 84 V- 264 V AC / 47 Hz- 63 Hz / Safety class 1

### Fuses

- Fuse 250 V- 4 A (slow-blow) – 2 fuses per power supply

### Environmental Conditions

- Operating temperature +5°C up to +45°C
- Relative humidity: 10%- 80%, non condensing

### Display

- 3.5" Backlight LED LCD, IPS Transmissive
- Touch display
- Resolution: 340 x 800 px

### Control

- 1 x Encoder knob with push functionality
- 2 x Push-Buttons

### Network

- 1 x RJ45 Gigabit Ethernet
- for managing the device (remote control)

### Remote Control

- globcon software control
- integrated web server with UI (HTML, JavaScript)
- Ember+ (license) - MGMT <IP Address>:9000
- OSC (license)

### Word Clock

- 2 x BNC socket (input / output)
- Impedance: 75  $\Omega$  (termination switchable)
- AES11 (DARS also supported)

**Sample Rate**

- 30 - 50 kHz @ 1 FS
- 60 - 100 kHz @ 2 FS
- 120- 200 kHz @ 4 FS

**Phones Out 1**

- 1 x 6.3 mm TRS jack, mono / stereo
- Output level: max. +18 dBu
- SNR: -115 dB RMS (20 Hz- 20 kHz) / -118 dB(A)
- THD+N @ 0 dBFS: -105 dB @ 600  $\Omega$

**Phones Out 2**

- 1 x 3.5 mm TRS jack, mono / stereo
- Output level: max. +12 dBu
- SNR: -115 dB RMS (20 Hz- 20 kHz) / -118 dB(A)
- THD+N @ 0 dBFS: -105 dB @ 600  $\Omega$

**USB**

- 1 x USB socket (Type A)
- 1 x USB socket (Type C), lockable with top-screw plug
- for legacy control via globcon bridge

**GPIO**

- 2 x GPI (MOSFET switch),
- 2 x GPO (MOSFET switch)

**MADI Port SFP**

- 2 x SFP (empty cage without module)

**MADI Format (I/O)**

- 48k Frame, 96k Frame
- High Speed mode, legacy pattern
- 56 channel, 57 channel, 64 channel

**Analog I/O level line**

- +15 / +18 / +24 dBu changeable via jumper on module

**MIC8.HD.I**

- Input sensitivity:-55 dBu to +30 dBu
- EIN:-128 dBu
- THD @-1 dBFS:-113 dB
- Frequency response:-0.15 dB (10 Hz) /-0.15 dB (20 kHz)
- 30 dB PAD (switchable)
- +48 V phantom power (switchable)

**MIC8.LINE.IO**

- Input sensitivity:-55 dBu to +24 dBu
- EIN:-118 dBu
- SNR:-115 dBFS (20 Hz- 20 kHz) /-118 dB(A) @ 0dB Gain
- THD @-1 dBFS:-113 dB
- Frequency response:-0.5 dB (10 Hz to FS/2)
- 9 dB PAD (switchable)
- +48 V phantom power (switchable)

**A/D**

- SNR:-117.6 dB RMS (20 Hz- 20 kHz) /-119.9 dB(A)
- THD @-1 dBFS: <-119 dB
- Frequency response: <-0,15 dB (10 Hz) /-0,15 dB (20 kHz)

**D/A**

- SNR:-116.8 dB RMS (20 Hz- 20 kHz) /-119.5 dB(A)
- THD @-1 dBFS:-109 dB
- Frequency response:-0,5 dB (10 Hz) /-0,15 dB (20 kHz)



**AN8.IO**

- 8 ch line input / output, 2 x DSUB-25, balanced

**AN8.O**

- 8 ch line output, 1 x DSUB-25, balanced

**AN8.I**

- 8 ch line input, 1 x DSUB-25, balanced

**MIC8.HD.I**

- 8 ch mic high definition input, 1 x DSUB-25, balanced

**MIC8.HD.IO**

- 8 ch mic high definition input / line output, 2 x DSUB-25, balanced

**MIC8.LINE.IO**

- 8 ch mic/line input / line output, 2 x DSUB-25, balanced

**MIC8.LINE.I**

- 8 ch mic/line input, 1 x DSUB-25, balanced

**AES4.IO**

- 4 port AES3 input / output, 1 x DSUB-25 (8 audio channels)

**AES4.SRC.IO**

- 4 port AES3 input with SRC / output, 1 x DSUB-25 (8 audio channels)

**MADI2.SRC.IO**

- MADI, 128 ch @ 1 FS, 64 ch @ 2 FS, 32 ch @ 4 FS
- 2 x SFP cage (matching SFP transceiver available from DirectOut)

**MADI2.BNC.SRC.IO**

- MADI, 128 ch @ 1 FS, 64 ch @ 2 FS, 32 ch @ 4 FS
- 2 x coaxial BNC input, 2 x coaxial BNC output, 75 Ω

**MADI4.IO / MADI4.SRC.IO**

- MADI, 256 ch @ 1 FS, 128 ch @ 2 FS, 64 ch @ 4 FS
- 4 x SFP cage (matching SFP transceiver available from DirectOut)

**RAV.IO / RAV.SRC.IO**

- Network Audio RAVENNA / AES67, 128 ch @ 1 FS, 64 ch @ 2 FS, 32ch @ 4 FS
- 2 x RJ45, 1x SFP

**DANTE.IO / DANTE.SRC.IO**

- Network Audio Dante, 64 ch @ 1 FS, 32 ch @ 2 FS, 16ch @ 4 FS
- 2 x RJ45, 1x SFP

**SG.IO / SG.SRC.IO**

- Network Audio Waves SoundGrid, 128 ch @ 1 FS, 64 ch @ 2 FS
- 2 x RJ45, 1x SFP

**MILAN.IO / MILAN.SRC.IO**

- Network Audio AVB / MILAN, 128 ch @ 1 FS, 64 ch @ 2 FS, 32 ch @ 4 FS
- 2 x RJ45, 1x SFP

**USB.IO**

- USB 3.0 Audio, 128 ch @ 1 FS, 64 ch @ 2 FS, 32 ch @ 4 FS
- USB 2.0 Audio, 64 ch
- USB C with USB 2/3 support and top screw locking
- Driver Windows: ASIO, WDM
- Driver macOS: Kernel Extension, Driver Kit Core Audio
- USB class-compliant mode with full USB 3.0 support and 128 channels I/O
- TotalMix FX

This page is left blank intentionally.

## Index

### A

Accessory	
BREAKOUT.....	17
Patch Chords .....	18
SFP Transceiver- MADI.....	19
AES59.....	47, 48, 49, 50, 52
Analog Split.....	46
ANDIAMO .....	58

### B

BREAKOUT.....	17
---------------	----

### C

Clocking.....	55
Conditions of Warranty	see Warranty
Conformity & Certificates	
CE.....	15
RoHS .....	15
WEEE .....	15
Contact .....	15
Contents.....	16
Conventions.....	7

### D

Defective Parts/Modules .....	12
Dimensions.....	62, 72
DSUB-9.....	71
DSUB-25.....	70

### E

Environmental Conditions.....	22, 62
-------------------------------	--------

### F

Feature Summary .....	9
First Aid .....	13
Fuses .....	62

### G

globcon .....	16
---------------	----

### I

Intended Operation.....	14
IP address	
default.....	24

### L

License	
installation .....	73

### M

MGMT .....	29
------------	----

### N

Network Standards .....	9
-------------------------	---

### P

Patch Chords .....	18
--------------------	----

### R

Remote Control .....	16
Reset	see Factory Reset

### S

Scaling Factor .....	26
SFP Transceiver.....	19
Support.....	60
System Update.....	73

### T

Technical Data.....	62
Troubleshooting .....	60

### U

Update Mode.....	73
Updates .....	14
USB Audio (USB.IO) .....	40, 58

### W

Warranty .....	14
WEEE	See Conformity & Certificates: WEEE
Word clock.....	54



## Appendix A - DSUB-25 Pin assignment

The pinout of the DSUB-25 connectors for the transmission of analog and AES3 audio signals follows the AES59 specification.

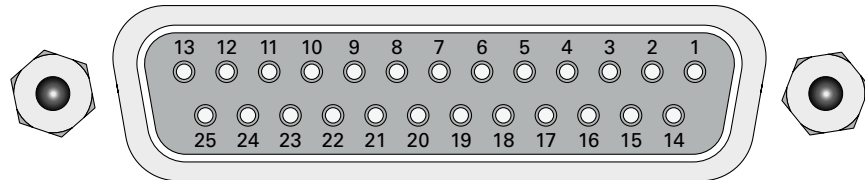

jack- female

<b>PIN</b>	<b>Signal analog</b>	<b>Signal digital</b>
1	CH 8 +	CH 4 OUT +
2	GND	GND
3	CH 7 -	CH 3 OUT -
4	CH 6 +	CH 2 OUT +
5	GND	GND
6	CH 5 -	CH 1 OUT -
7	CH 4 +	CH 4 IN +
8	GND	GND
9	CH 3 -	CH 3 IN -
10	CH 2 +	CH 2 IN +
11	GND	GND
12	CH 1 -	CH 1 IN -
13		
14	CH 8 -	CH 4 OUT -
15	CH 7 +	CH 3 OUT +
16	GND	GND
17	CH 6 -	CH 2 OUT -
18	CH 5 +	CH 1 OUT +
19	GND	GND
20	CH 4 -	CH 4 IN -
21	CH 3 +	CH 3 IN +
22	GND	GND
23	CH 2 -	CH 2 IN -
24	CH 1 +	CH 1 IN +
25	GND	GND

## Appendix B - DSUB-9 Pin assignment

The pinout of the DSUB-9 connector for the GPI (General Purpose Input) and GPO (General Purpose Output) connection.

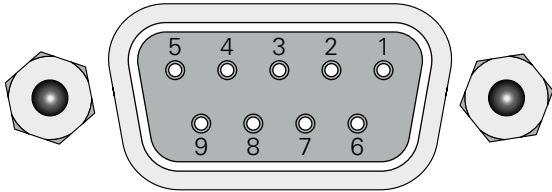

jack- female

PIN	Signal
1	GND
2	GND
3	GND
4	+ 12 V
5	+ 12 V
6	GPI 2
7	GPI 1
8	GPO 2
9	GPO 1

GPI - 3.3 V CMOS compatible, low active

Can be triggered by connecting the input pin with ground (GND) or by a voltage source between input pin and ground.

Input voltage: max 30 V DC

GPO - Open drain MOSFET switch - max. 30 V, max. 200 mA.

Power supply: + 12 V, max. 200 mA (in total)

The pinout (3, 4, 5, 8, 9) complies with the GPO of PRODUCER.COM

### Appendix C - Dimensions

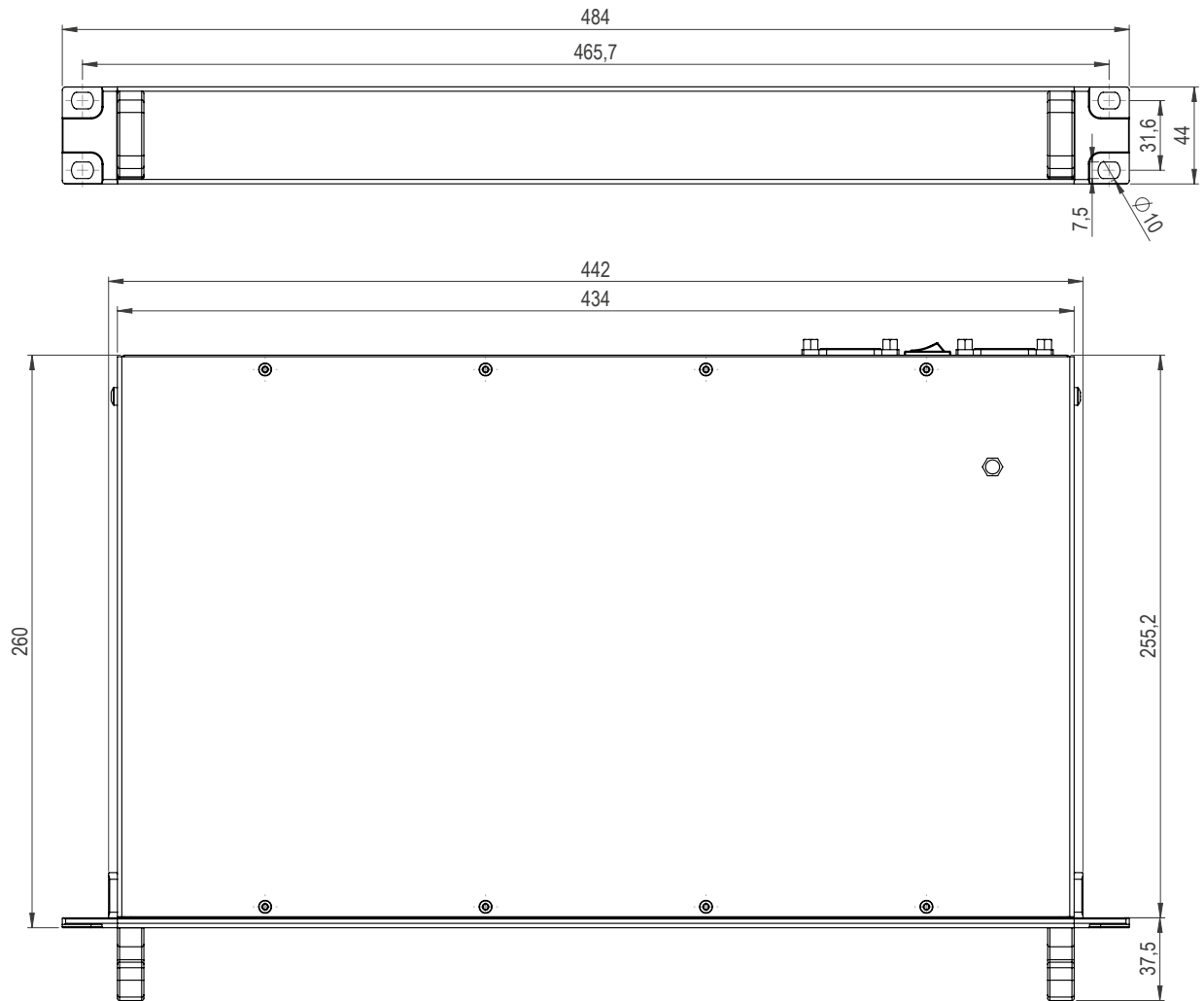



## Appendix D - System Update & License Installation

To update the system of MAVEN or to install a license the device must be rebooted in Update Mode.

### **WARNING!**



It is strongly recommended to backup the device configuration before running any update.

### **NOTE**



During the update the device will reboot and audio will be interrupted

1. Download image archive from the product page at [www.directout.eu](http://www.directout.eu)
2. Unzip the image file => maven<xx>\_system\_update\_<build>\_<date>.mvup
3. Start the device in Update Mode:
  - Press and hold the button MENU on the front panel and switch the device on.
  - Once the DirectOut logo disappears you may release the button.
4. Enter the device's <IP address>:8080 in your browser (Mozilla Firefox or Google Chrome). The IP address is displayed in the front panel display. The IP address may vary in update mode when the network settings are set to DHCP.
5. Choose the downloaded file for upload (\*.mvup) and start with 'UPDATE!'  
The entire update may take a couple of minutes.



Once the update is stored into the device will become offline, reboot and become online again.

**DirectOut GmbH**

Hainichener Str. 66a  
09648 Mittweida  
Germany

T: +49-3727-5650-00  
M: [info@directout.eu](mailto:info@directout.eu)  
[www.directout.eu](http://www.directout.eu)